



Air-to-water Heat Pump Split Versati

Commercial AC R&D Department I

October , 2015

Contents

PRODUCT	6
1 Product Data.....	7
1.1 Lineup.....	7
1.1.1 Main Unit.....	7
1.1.2 Water Tank	7
1.2 Nomenclature.....	8
1.2.1 Main Unit.....	8
1.2.2 Water Tank	8
1.3 Product Features.....	8
1.3.1 General	8
1.3.2 Features.....	9
1.4 Operating Principle	11
1.4.1 Schematic Diagram	11
1.5 Technical Data	12
1.5.1 Parameter List	12
1.5.2 Nominal Working Conditions	13
1.5.3 Operation Range	14
1.5.4 Electric Data	14
1.5.5 Capacity Correction	15
2 Outline Dimensions	15
2.1 Outline dimensions of outdoor unit.....	15
2.2 Outline dimensions of indoor unit	16
3 Explosive Views and Part Lists	17
4 Supply Scope	21
Design and Selection	22
1 Installation Example	23
2 Model Selection.....	25
2.1 Speculations of Power Supply	25
2.2 Operation Conditions	25
2.3 Flowchart of Model Selection.....	26
2.4 Design Principle	26
3 Selection of the Underfloor Coils.....	26
3.1 Calculation of Unit Load for Floor Heating.....	26
3.2 Selection of Tube Spacing of the Underfloor Coils.....	27
3.3 Selection of Loop Quantity of Coils for Each Room	27
3.3.1 Type of Underfloor Coils.....	27
3.3.2 Selection of Loop Quantity for Each Room	28
4 Quantity and Location of the Water Traps and Collectors.....	28
4.1 Design Requirements on Loop Quantity for Circulation Water	28
4.2 Requirements on Installation of the Water Trap (Collector).....	30
5 Section of FCU	30
5.1 FCU Type Selection.....	30
5.2 Matching of Capacity	30
6 Selection of the Water Tank.....	31

6.1 Specifications of the Water Tank	31
6.2 Volume Selection of the Water Tank	31
6.2.1 Selection Based on Water Consumption Per Capita	31
6.2.2 Selection Based on Sanitary Utensils	32
6. 2.3 Selection of the Water Tank	32
7 Examples for Model Selection.....	32
7.1 General Introduction to the Example Project.....	32
7.2 Heat Load Calculation.....	32
7.2.1 Load Calculation of a Single Floor	32
7.2.2 Arrangement Design of the Underfloor System for A Single Floor	33
7.2.3 Arrangement Design of the Underfloor System for the Bath Room.....	33
7.2.4 Arrangement Design of the Underfloor System for the Master and Bath Rooms.....	33
7.2.5 Check.....	33
7.3 Model Selection.....	34
UNIT CONTROL.....	35
1 Integral Control Concept	36
1.1 Control Principle Diagram	36
1.2 Control Flowchart.....	39
2 Main Control Logics.....	39
2.1 Cooling	39
2.1.1 Control to the Compressor	39
2.1.2 Freeze Protection	40
2.2 Heating	40
2.2.1 Control to the Compressor	40
2.2.2 Over-temperature Protection.....	40
2.2.3 Control to the Auxiliary Electric Heater.....	40
2.3 Water Heating	40
2.3.1 Water Heating by the Main Unit	40
2.3.2 Water Heating by the Solar System	41
2.4 Shutdown	41
2.5 Control to the Compressor.....	41
2.6 Control to the Fan	41
2.7 Control to the 4-way Valve.....	42
2.8 Control to the Water Pump	42
2.9 Control the Electrostatic Expansion Valve.....	42
2.10 Protection Control	42
3 Controller	43
3.1 External View	43
3.1.1 Keys & Indicating LEDs	43
3.1.2 Standby Page and Homepage	44
3.2 Operation Instructions.....	45
3. 2.1 On/Off	45
3.2.2 Function Setting.....	46
3.2.3 Parameter Setting (Parameter Set).....	66
3. 2.4 View	69
3. 2.5 General Setting.....	74

3. 2.6 Key Lock	76
UNIT INSTALLATION	77
1. Installation Guides	78
1.1 Installation Positions of the outdoor unit	79
1.2 Installation Positions of the indoor unit	79
1.3 Matters Need Attention	79
2 Filed Supplied Pipes and Valves	79
3 Service Tools	81
4 Instalaltion Instructions	81
4.1 Installation Examples	81
4.2 Pre-Installation	84
4.3 Selection of Installation Location	84
4.4 Outline Dimension of Outdoor Unit	84
4.5 Installation Clearance Data	85
4.6 Outline Dimension of Indoor Unit	86
4.7 Installation Clearance Data	87
4.8 Electric Wiring	87
4.9 Wiring of the Terminal Board	90
4.10 Wiring of the 2-Way Valve	91
4.11 Wiring of Other Auxiliary Heat Sources	91
4.12 Wiring of the Gate-Controller	92
4.13 Wiring of the Remote Air Temperature Sensor	93
4.14 Wiring of the Thermostat	94
4.15 Wiring of the Control	95
5 Commissioning and Trial Run	95
5.1 Check before startup	95
5.2 Test run	96
Test Operation & Troubleshooting & Maintenance	98
1 Trial Run	99
1.1 Check for Wiring	99
1.2 Check for the Water System	99
1.3 Check for the Communication System	99
1.4 Trial Run	99
2 Error Code List	100
3 Flow Chart Of Troubleshooting	102
3.1 Comp High-pressure Protection E1	102
3.2 Comp Low- pressure Protection E3	103
3.3 Comp Discharge Temp Protection E4	104
3.4 Overload Protection of Compressor or Driver Error	105
3.5 DC Fan Error EF	106
3.6 Temperature Sensor Error	106
3.7 Communication Malfunction E6	107
3.8 Capacity Switch Error (Code:"C5")	108
4 Diagnosis of Driving	108
4.1 Diagnosis Flowchart of Driving of Single-phase Unit and Three-phase Unit	108
5 Daily Maintenance and Repair	113

5.1 Daily Maintenance	113
5.2 Troubleshooting	113
5.3 Repair	114
5.3.1 Key Components	114
5.3.2 Charging and Discharging of Refrigerant	116

PRODUCT

Product



1 Product Data

1.1 Lineup

1.1.1 Main Unit

Series	Model	Product Code	Cooling Capacity (kW)	Heating Capacity (kW)	Power Supply	Refrigerant	Appearance
VERSATI □+	GRS-CQ8.0Pd/NaD-K	ER01001210	8.2	8.0	220-240V, ~,50Hz	R410A	
	GRS-CQ1.0Pd/NaD-K	ER01001220	9.7	9.2			
	GRS-CQ1.2Pd/NaD-M	ER01001190	13.5	12	380-415V, 3N~,50Hz		
	GRS-CQ1.4Pd/NaD-M	ER01001200	14	14			

1.1.2 Water Tank

Model	Product Code	Nominal Cubage(L)	Appearance
SXVD200LCJ/A-K	ER20000160	200	
SXVD200LCJ/A-M	ER20000240	200	
SXVD300LCJ/A-K	ER20000180	300	
SXVD300LCJ/A-M	ER20000250	300	
SXVD200LCJ2/A-K	ER20000170	200	
SXVD200LCJ2/A-M	ER20000260	200	
SXVD300LCJ2/A-K	ER20000190	300	
SXVD300LCJ2/A-M	ER20000270	300	

1.2 Nomenclature

1.2.1 Main Unit

G	RS	-	C	Q	14	Pd	/	Na	D	-	M	(O)
1	2		3	4	5	6		7	8		9	10

NO.	Description	Options
1	GREE	G-GREE Air to water heat pump
2	Heat Pump Water Heater	RS
3	Heating Mode	S= Static; C=Circulating
4	Function	Q=Multi-function; Omit=Single-function
5	Nominal Heating Capacity	6.0=6.0kW; 8.0=8.0kW;10=10kW; 12=12kW; 14=14kW; 16=16kW
6	Compressor Style	Pd=DC Inverter; Omit=On/Off
7	Refrigerant	Na=R410A
8	Design Serial Number	B,C,D.....
9	Power Supply	K=220-240V,~,50Hz; M=380-415V,3N~,50Hz;H=380V,3N~,60Hz
10	Indoor and Outdoor Unit Code	I=Indoor unit; O=Outdoor unit

1.2.2 Water Tank

SX	V	D	200	L	C	J2	/	A	-	K
1	2	3	4	5	6	7		8		9

NO.	Description	Options
1	Symbol of Heat Pump Water Tank	SX
2	Tank Type	Default-Common heat pump water tank; V-Heat pump water tank for multi VRF system
3	Function Code	Default-No electric heating function; D-Electric heating function available
4	Nominal Water Tank Volume	200=200L,300=300L
5	Structure Type	B-Wall mounted type; L-Floor standing type
6	Bearing	Default-Non-bearing water tank; C-Bearing water tank
7	Type of Heat Exchange Tube	Default-No heat exchanger; J-Inner coil static heating(J-Single coil; J2-Double coils); JW-Outer coil static heating
8	Serial Number	A,B,C.....
9	Power Supply	K=220-240V,~,50Hz; M=380-415V,3N~,50Hz; H=380V,3N~,60Hz

1.3 Product Features

1.3.1 General

The Versati⁺ split unit is designed specially for the European market where there is a demand for high-temperature water. Thanks to the dual-stage compression and enthalpy gain through gas injection, the heating energy efficiency at low temperature will rise up greatly with the leaving water temperature

Product

up to 60°C. The whole series of products strictly comply with EN14511-2100 and EUROVENT energy efficiency Class A. Their COP can reach up to 4.5. This split unit can realize space heating and sanitary hot water supply through terminal units, like the fan coil unit, floor coil and radiator. Environment-friendly refrigerant R410A is adopted for the split unit, with ODP of 0 and quite low GWP. Besides, the adopted heat pump technologies will reduce consumption of coal and other energy source and lower greatly CO₂ emission. Ranged from 8.0kW~14kW, it is widely applicable to small and medium-sized apartment, large-sized villa etc.

1.3.2 Features

◆ Wide Operation Range

Heating: -20~35°C; Cooling: 10~48°C; Water Heating: -20~45°C

◆ Unique Low-Temp Hi-heat Dual-stage Compressor

1. Under low-temperature conditions, compared with the conventional compressor, the dual-stage low-temp hi-heat compressor will generate less loss of heat capacity and get higher energy efficiency.

2. Floodback, high discharge temperature and other problems can be completely avoided under low-temp conditions and the compressor's reliability will be enhanced greatly.

3. Dual-stage compression, dual-stage throttling and intermediate enthalpy adding through gas injection will raise the leaving water temperature and improve the control accuracy.

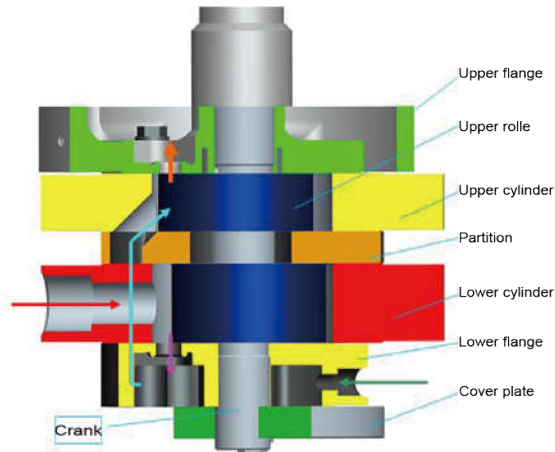

◆ High-efficiency Component(Inverter pump, Inverter fan, Plate heat exchanger)

1. The A-class high-efficiency inverter water pump which complies with the European Erp directive, can control the running frequency based on the actual load. Therefore, it can enhance the operation efficiency and control the water temperature more accurately.

2. The DC inverter fan can control the air volume accurately and make the system run more stably and save more energy.

3. The high-efficiency plate heat exchanger will improve the unit's performance largely.



◆ All-in-one Design

1. The unit can integrate with terminal units, like the radiator, floor heating device, FCU, water heating device, solar kit, gas furnace and swimming pool etc. Versatile functions can meet various kinds of demands

Product

from different users and enhance applicability of this product.

2. The all-in-one structure design can save more installation cost, reduce risks of refrigerant leak, and improve safety and reliability of the system.

◆ Brand-new Controller

1. White appearance, exquisite design, and the wall-mounted design will facilitate installation.

2. The dot-matrix display can show in both English and Chinese to show information in a more direct and convenient way.

3. The six-lattice display pattern will accommodate more information.

4. The 12V JACK interface can supply power to the control separately and lengthen the communication distance.

5. The remote monitoring interface can monitor the unit through the Modbus interface and be integrated into the BMS system.



◆ Smart Control, Powerful Function

1. The running mode can be switched freely. Furthermore, based on different demands, the holiday mode, environment-dependent mode, quiet timer, temperature timer and floor commissioning can be activated.

2. Multiple protections can make this product much safer. The added electric heater will prevent the plate heat exchanger from being frostbitten owing to too low water temperature and resultantly extend the service life of the product and enhance its safety and reliability.

3. The newly developed smart defrosting control program, “do defrost when necessary; do not defrost when unnecessary; defrost more when it frosts heavily; defrost less when it frosts lightly”, can bring more comfortability, avoid inadequacy of heat supply and ensure sustainable heat supply for the users.

1.4 Operating Principle

1.4.1 Schematic Diagram

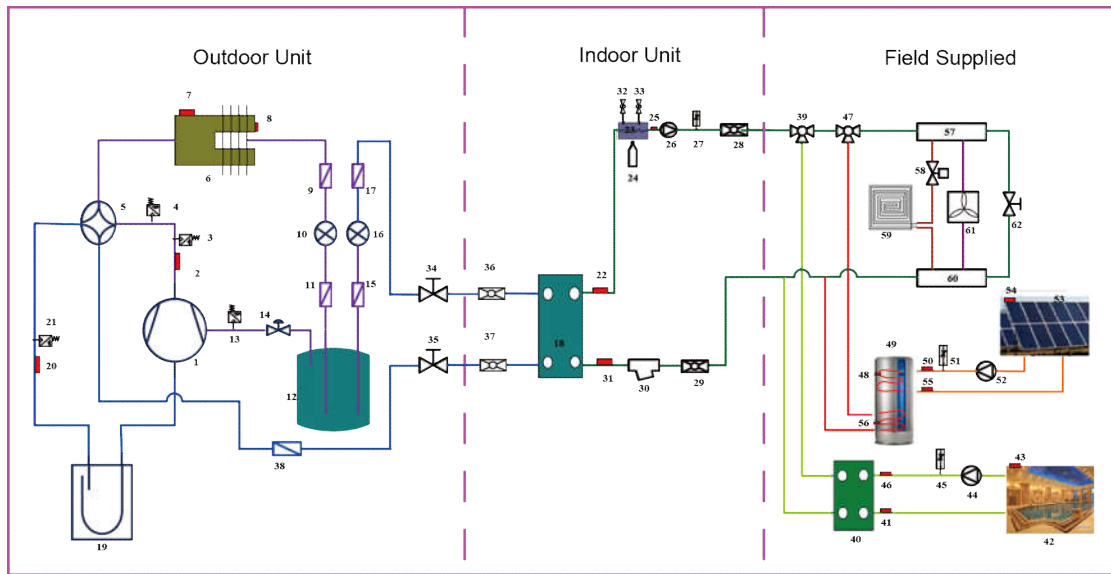

No.	Name	No.	Name	No.	Name
1	Compressor	22	Leaving Water Temperature of the Plate Exchanger	43	Water Temperature Sensor of the Swimming Pool
2	Discharge Temperature Sensor	23	Electric Heater	44	Water Pump for the Swimming Pool
3	High Pressure Switch	24	Expansion Tank	45	Flow Switch for the Swimming Pool
4	Pressure Sensor	25	Leaving Water Temperature of the Electric Heater	46	Entering Water Temperature Sensor for the Swimming Pool
5	4-way Valve	26	Water Pump	47	Electric 3-way Valve 2
6	Finned Exchanger	27	Flow Switch	48	Water Tank Temperature Sensor 1
7	Environment Temperature Sensor	28	Leaving Water Pipe Connector	49	Water Tank
8	Defrosting Temperature Sensor	29	Entering Water Pipe Connector	50	Leaving Water Temperature Sensor of the Solar System
9	Filter	30	Water Filter	51	Flow Switch for the Solar System
10	Electrostatic Expansion Valve 1	31	Leaving Water Temperature of Plate Exchanger	52	Water Pump for the Solar System
11	Filter	32	Automatic Exhaust Valve	53	Solar Panel
12	Flasher	33	Safety Valve	54	Solar Panel Temperature Sensor

Product

13	Pressure Sensor	34	Liquid Valve	55	Entering Water Temperature for the Solar System
14	Solenoid Valve	35	Gas Valve	56	Water Tank Temperature Sensor 2
15	Filter	36	Liquid Valve Connector	57	Water Knockout Vessel
16	Electrostatic Expansion Valve 2	37	Gas Valve Connector	58	Electric 2-way Valve 1
17	Filter	38	Filter	59	Floor Radiator
18	Plate-type Exchanger	39	Electric 3-way Valve 1	60	Water Collector
19	Vapor-liquid Separator	40	Plate Exchanger for the Swimming Pool	61	FCU
20	Suction Temperature Sensor	41	Leaving Water Temperature Sensor for the Swimming Pool	62	Pressure Differential By-pass Valve
21	Pressure Sensor	42	Swimming Pool		

1.5 Technical Data

1.5.1 Parameter List

Model			GRS-CQ8.0Pd /NaD-K	GRS-CQ10Pd/ NaD-K	GRS-CQ12Pd/ NaD-M	GRS-CQ14Pd/ NaD-M
Product Code			ER01001210	ER01001220	ER01001190	ER01001200
Capacity* ¹	Cooling(floor cooling)	kW	8.2	9.7	13.5	14
	Heating(floor heating)	kW	8	9.2	12	14
Power Input* ¹	Cooling(floor cooling)	kW	1.86	2.46	3.46	3.68
	Heating(floor heating)	kW	1.85	2.19	2.67	3.33
EER* ¹ (floor cooling)		W/W	4.41	3.94	3.90	3.80
COP* ¹ (floor heating)		W/W	4.32	4.20	4.49	4.20
Capacity* ²	Cooling(for Fan coil)	kW	5.5	6.9	9.6	10
	Heating(Fan coil or Radiator)	kW	7.7	9	12	12.8
Power Input* ²	Cooling(for Fan coil)	kW	1.85	2.34	3.02	3.22
	Heating(Fan coil or Radiator)	kW	2.26	2.65	3.24	3.56
EER* ² (for Fan coil)		W/W	2.97	2.95	3.18	3.11
COP* ² (Fan coil or Radiator)		W/W	3.41	3.40	3.70	3.60
Refrigerant charge volume		kg	5.3	5.3	5.3	5.3
Sanitary water Temperature		°C	40~80	40~80	40~80	40~80

Product

Outdoor Unit Model			GRS-CQ8.0Pd /NaD-K(O)	GRS-CQ10Pd/ NaD-K(O)	GRS-CQ12Pd/ NaD-M(O)	GRS-CQ14Pd/ NaD-M(O)
Outdoor Unit Product Code			ER010W1210	ER010W1220	ER010W1190	ER010W1200
Sound Pressure Level	cooling	dB(A)	53	53	57	57
	heating	dB(A)	54	54	57	57
Dimension s (W×D×H)	Outline	mm	980×427×788		900×412×1345	
	Packaged	mm	1094×474×847		980×440×1380	
Net weight/Gross weight		kg	85/87		126/136	
Indoor Unit Model			GRS-CQ8.0Pd /NaD-K(I)	GRS-CQ10Pd/Na D-K(I)	GRS-CQ12Pd/ NaD-M(I)	GRS-CQ14Pd/Na D-M(I)
Indoor Unit Product Code			ER010N1210	ER010N1220	ER010N1190	ER010N1200
Sound Pressure Level	cooling	dB(A)	31	31	31	31
	heating	dB(A)	31	31	31	31
Dimension s (W×D×H)	Outline	mm	981×324×500		981×324×500	
	Packaged	mm	1040×380×605		1040×380×605	
Net weight/Gross weight		kg	56/65		58/67	

Notes

“*1” indicates the capacity and power input are tested based on the conditions below:

Cooling

Indoor Water Temperature: 23°C/18°C; Outdoor Temperature: 35°CDB/24°CWB

Heating

Indoor Water Temperature: 30°C/35°C; Outdoor Temperature: 7°CDB/6°CWB

“*2” indicates the capacity and power input are tested based on the conditions below:

Cooling

Indoor Water Temperature: 12°C/7°C; Outdoor Temperature: 35°CDB/24°CWB

Heating

Indoor Water Temperature: 40°C/45°C; Outdoor Temperature: 7°CDB/6°CWB

1.5.2 Nominal Working Conditions

Item	Water Side		Heat Source/User Side	
	Entering Water Temp (°C)	Leaving Water Temperature (°C)	Dry Bulb Temperature (°C)	Wet Bulb Temperature (°C)
FCU Cooling	12	7	35	—
FCU Heating	40	45	7	6
Floor Cooling	23	18	35	—
Floor Heating	30	35	7	6
Water Heating	53	-	7	6

Product

1.5.3 Operation Range

Item	Water Side	Heat Source/User Side
	Leaving Water Temperature (°C)	Environment Dry Bulb Temperature (°C)
Cooling	7~25	10~48
Heating	25~60	-20~35
Water Heating	40~80 (Water Tank Temperature)	-20~45

Note: when operating conditions are out of the range listed above, please contact GREE.

1.5.4 Electric Data

Model	Power Supply	Leakage Switch	Minimum Sectional Area of Earth Wire	Minimum Sectional Area of Power
	V,Ph,Hz	(A)	(mm ²)	(mm ²)
GRS-CQ8.0Pd/NaD-K(O)	220-240V,~,50Hz	25	3.3	2×3.3
GRS-CQ10Pd/NaD-K(O)		25	3.3	2×3.3
GRS-CQ8.0Pd/NaD-K(I)		50	13.3	2×13.3
GRS-CQ10Pd/NaD-K(I)		50	13.3	2×13.3
GRS-CQ12Pd/NaD-M(O)	380-415V,3N~,50Hz	20	2.1	4×2.1
GRS-CQ14Pd/NaD-M(O)		20	2.1	4×2.1
GRS-CQ12Pd/NaD-M(I)		20	3.3	4×3.3
GRS-CQ14Pd/NaD-M(I)		20	3.3	4×3.3

Notes

- ① Leakage Switch is necessary for additional installation. If circuit breakers with leakage protection are in use, action response time must be less than 0.1 second, leakage circuit must be 30mA.
- ② The above selected power cable diameters are determined based on assumption of distance from the distribution cabinet to the unit less than 75m. If cables are laid out in a distance of 75m to 150m, diameter of power cable must be increased to a further grade.
- ③ The power supply must be of rated voltage of the unit and special electrical line for air-conditioning.
- ④ All electrical installation shall be carried out by professional technicians in accordance with the local laws and regulations.
- ⑤ Ensure safe grounding and the grounding wire shall be connected with the special grounding equipment of the building and must be installed by professional technicians.
- ⑥ The specifications of the breaker and power cable listed in the table above are determined based on the maximum power (maximum amps) of the unit.
- ⑦ The specifications of the power cable listed in the table above are applied to the conduit-guarded multi-wire copper cable (like, YJV XLPE insulated power cable) used at 40°C and resistible to 90°C(see IEC 60364-5-52). If the working condition changes, they should be modified according to the related national standard.
- ⑧ The specifications of the breaker listed in the table above are applied to the breaker with the working temperature at 40°C. If the working condition changes, they should be modified according to the related national standard.

Product

1.5.5 Capacity Correction

◆ Cooling Capacity Correction

GRS-CQ8.0Pd/NaD-K, GRS-CQ10Pd/NaD-K, GRS-CQ12Pd/NaD-M, GRS-CQ14Pd/NaD-M

Performance correction					
Leaving Chilled Water □(□)	Ambient Temperature □(□)				
	25(77)	30(86)	35(95)	40(104)	45(113)
5(41.0)	0.995	0.955	0.905	0.855	0.805
6(42.8)	1.045	1.005	0.955	0.905	0.855
7(44.6)	1.090	1.050	1.000	0.950	0.900
8(46.4)	1.145	1.102	1.052	1.000	0.950
9(48.2)	1.190	1.150	1.100	1.050	1.002
10(50.0)	1.245	1.200	1.150	1.100	1.050
11(51.8)	1.290	1.250	1.202	1.152	1.102
12(53.6)	1.340	1.300	1.252	1.200	1.152
13(55.4)	1.390	1.350	1.302	1.252	1.202
14(57.2)	1.442	1.402	1.350	1.302	1.252
15(59.0)	1.490	1.450	1.400	1.350	1.302
18(64.4)	1.539	1.502	1.451	1.402	1.350

Computer of actual cooling capacity: actual cooling capacity = nominal cooling capacity x cooling capacity correction coefficient.

◆ Heating Capacity Correction

GRS-CQ8.0Pd/NaD-K, GRS-CQ10Pd/NaD-K, GRS-CQ12Pd/NaD-M, GRS-CQ14Pd/NaD-M

Performance Correction									
Outflow Heated Water □(□)	Ambient Temperature □(□)								
	-15(5)	-10(14)	-5(23)	0(32)	5(41.0)	10(50)	15(59.0)	20(68.0)	25(77.4)
30(86)	0.81	0.91	1.00	1.10	1.18	1.26	1.35	1.41	1.45
35(95)	0.74	0.84	0.93	1.03	1.11	1.19	1.28	1.36	1.41
40(104)	0.67	0.77	0.87	0.96	1.04	1.12	1.20	1.25	1.31
45(113)	0.60	0.70	0.80	0.89	0.97	1.05	1.13	1.19	1.25
50(122)	0.53	0.63	0.73	0.82	0.90	0.98	1.06	1.11	1.18
55(131)	0.46	0.56	0.66	0.74	0.83	0.90	0.98	1.05	1.10

Computer of actual heating capacity: actual heating capacity = nominal heating capacity x heating capacity correction coefficient.

2 Outline Dimensions

2.1 Outline dimensions of outdoor unit

◆ GRS-CQ8.0Pd/NaD-K(O), GRS-CQ10Pd/NaD-K(O)

Product

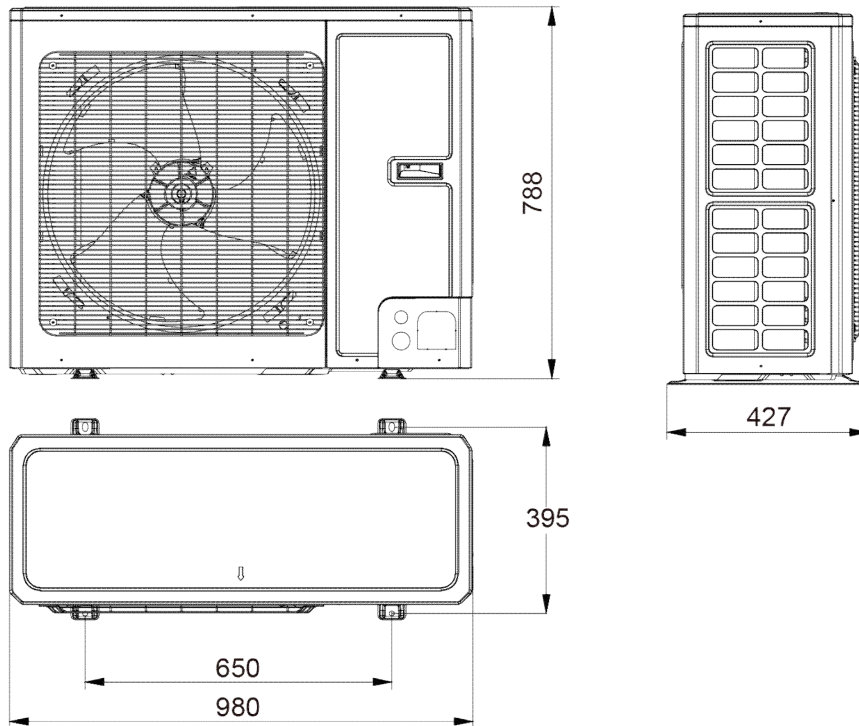

◆ GRS-CQ12Pd/NaD-M(O), GRS-CQ14Pd/NaD-M(O)

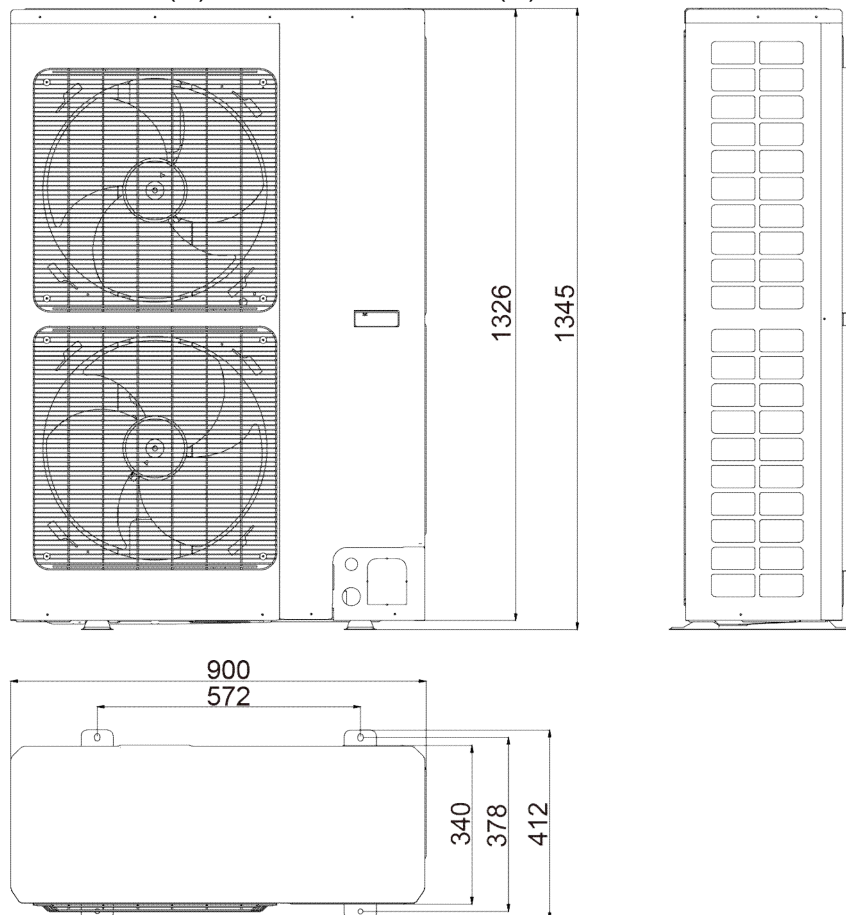

2.2 Outline dimensions of indoor unit

◆ GRS-CQ8.0Pd/NaD-K(I), GRS-CQ10Pd/NaD-K(I)

Product

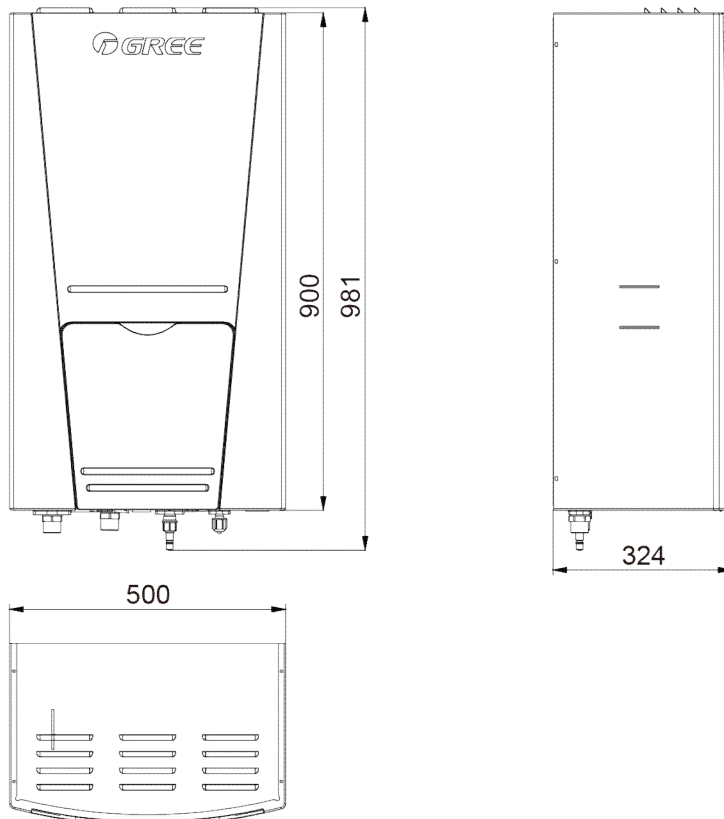

◆ GRS-CQ12Pd/NaD-M(I), GRS-CQ14Pd/NaD-M(I)

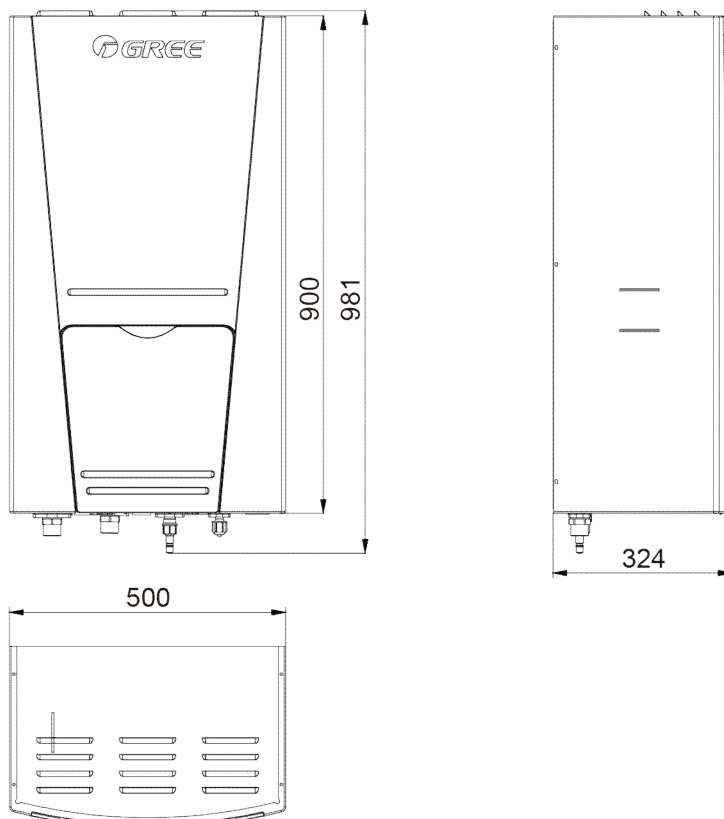

3 Explosive Views and Part Lists

(1) GRS-CQ12Pd/NaD-M(I), GRS-CQ14Pd/NaD-M(I)

Product

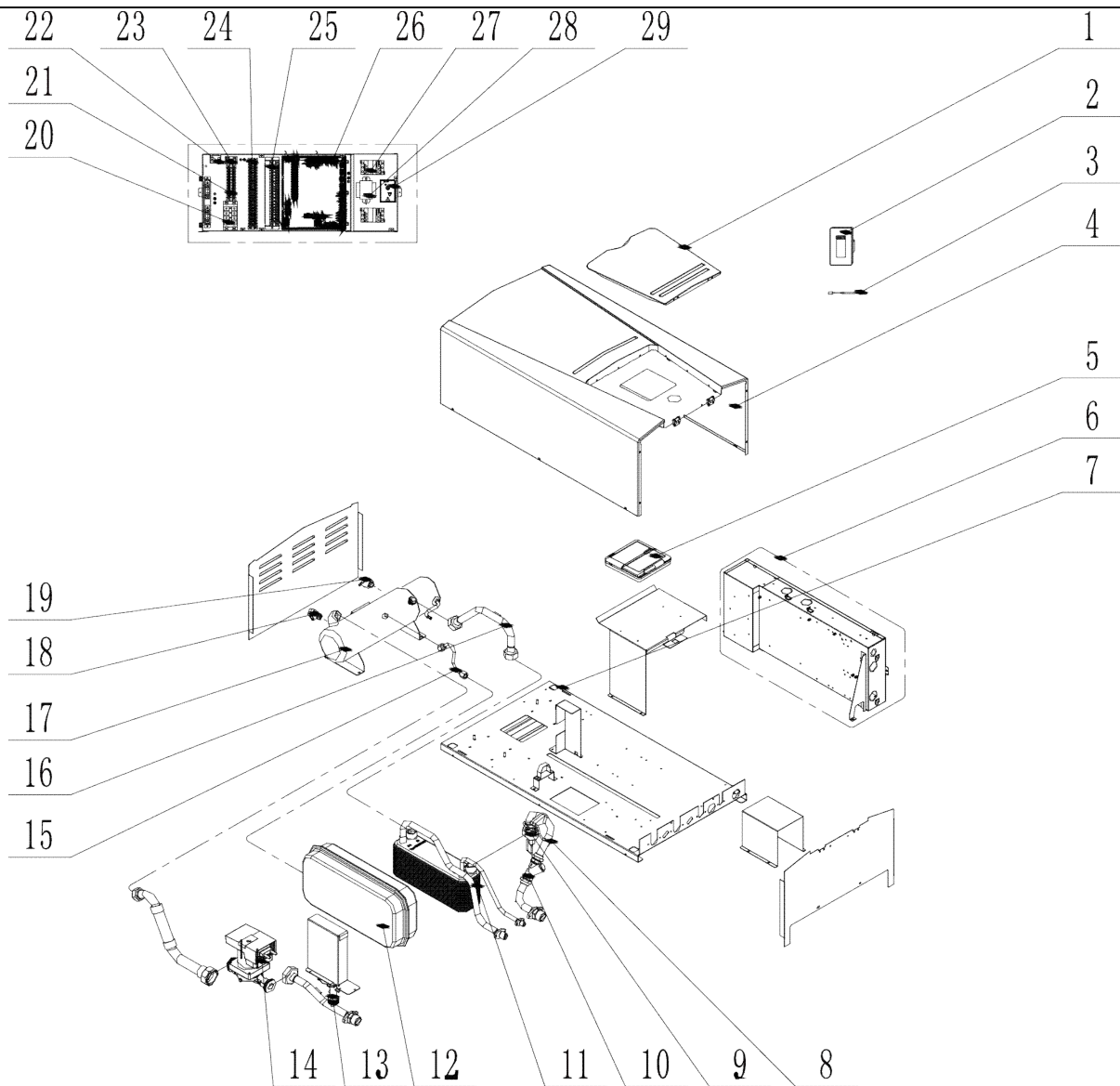

Parts List of GRS-CQ12Pd/NaD-M(I) for ER010N1190, GRS-CQ14Pd/NaD-M(I) for ER010N1200

No.	Name of part	Part Code	Quantity
1	Front panel cover	01262866P	1
2	Receiver Board	30261014	1
3	Temperature Sensor	3900028316G	1
4	Front Panel	01542808	1
5	Display Board	30292000031	1
6	Electric Box Assy	01392800199	1
7	Chassis	01282800058	1
8	Temp Sensor Sleeve	05212423	3
9	Water Pressure Gauge	49028009	1
10	Strainer	07412808	1
11	Plate-type Heat Exchanger	00902800030	1
12	Expansion Drum	07422800004	1
13	Steam current Switch sub- Assy	45028062	1
14	Water Pump	43138223	1
15	Connection Pipe	05022800323	1
16	Enter Water Pipe	04262800139	1

Product

17	Electric Heater	32000004	1
18	Relief Valve	07382814	1
19	Auto Air Outlet Valve	07108208	1
20	Terminal Board	42011051	1
21	Terminal Board	42011135	1
22	Thermostat	4504800201	1
23	Terminal Board	42011103	1
24	Terminal Board	42010249	1
25	Terminal Board	42011254	1
26	Main Board	30223000060	1
27	AC Contactor	44010232	2
28	Transformer	4311027001	1
29	Filter Board	30226000065	1

(2) GRS-CQ12Pd/NaD-M(O), GRS-CQ14Pd/NaD-M(O)

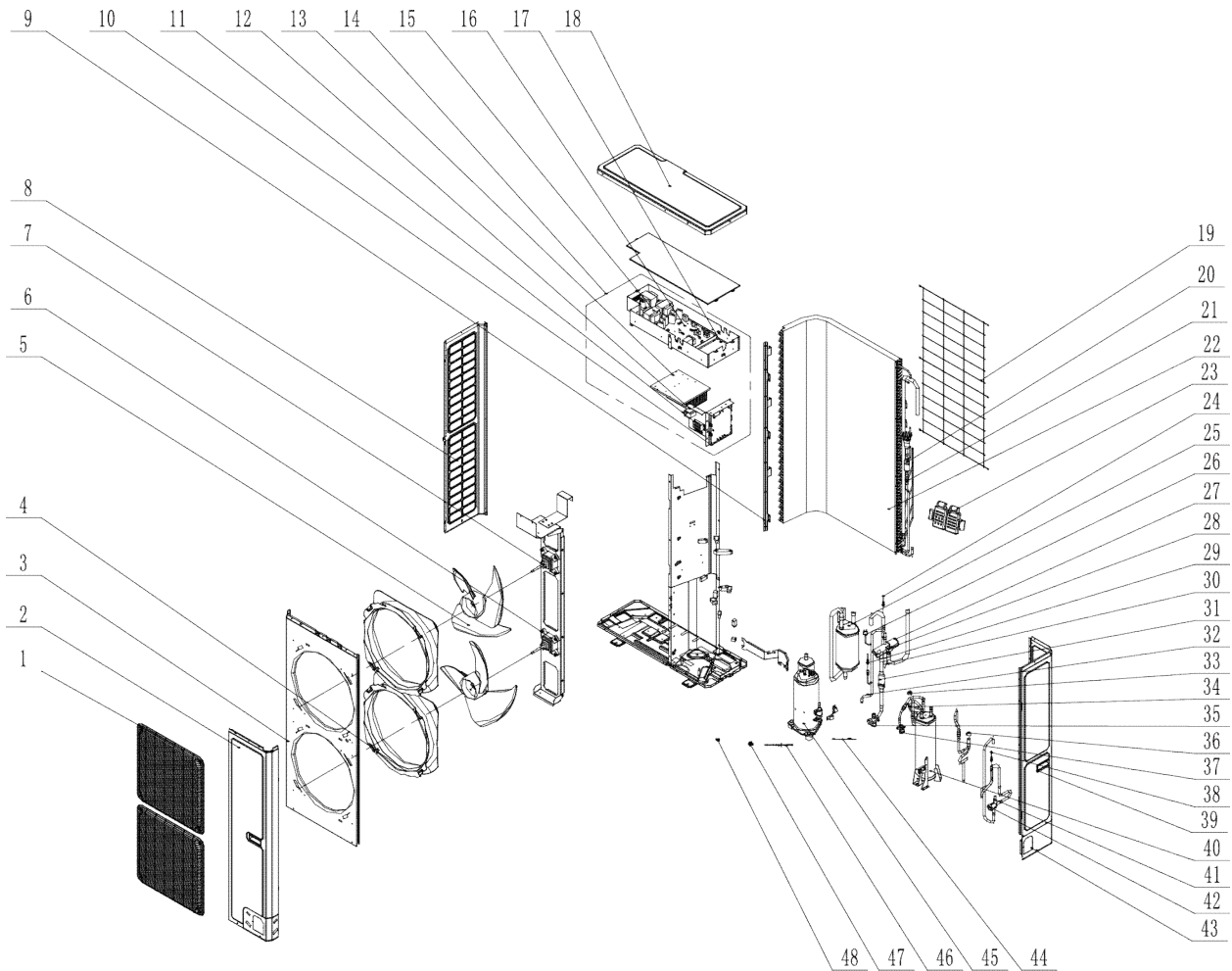

Parts List of GRS-CQ12Pd/NaD-M(O) for ER010W1190, GRS-CQ14Pd/NaD-M(O) for ER010W1200

No.	Name of part	Part Code	Quantity
1	Front Grill	01574100009	2
2	Front Side Plate	01314100012P	1
3	Cabinet	01514100002P	1
4	Diversion Circle	10474100001	2

Product

5	Axial Flow Fan	10338731	2
6	Brushless DC Motor	15704100013	1
7	Brushless DC Motor	1570410001301	1
8	Left Side Plate	01314100013P	1
9	Supporting Strip(Condenser)	01894100026	1
10	Filter Board	30223000044	1
11	Terminal Board	42011221	1
12	Inductance	43128000014	1
13	Radiator	49018000074	1
14	Electric Box Assy	01392800196	1
15	Reactor	43130192	3
16	Main Board	30223000013	1
17	Main Board	30224000106	1
18	Coping	01264100008P	1
19	Rear Grill	01574100004	1
20	Silencer	07245012	1
21	Strainer	0721212101	4
22	Condenser Assy	01122800089	1
23	Sensor Support	26905202	1
24	Sensor (High Pressure)	322101032	1
25	Gas-liquid Separator Sub-Assy	0722501801	1
26	Pressure Protect Switch	460200062	1
27	4-Way Valve	43040000002	1
28	Magnet Coil	4300040030	1
29	Sensor	322101002	1
30	Temp Sensor Sleeving	05212423	2
31	Strainer	07210037	1
32	Temp Sensor Sleeving	05210001	1
33	Electric Expand Valve Fitting	4304413238	1
34	Electronic Expansion Valve	07334468	2
35	Cut off Valve	07334100016	1
36	Electric Expand Valve Fitting	4304413221	1
37	Cut off Valve	07330000002	1
38	Pressure Sensor(High Pressure)	322101036	1
39	Handle	26235253	2
40	Accumulator	035029000001	1
41	Magnet Coil	4300040075	1
42	Electromagnetic Valve	43000073	1
43	Right Connection Board	01344100003P	1
44	Electrical Heater(Compressor)	7651521216	1
45	Compressor and Fittings	00202800017	1
46	Electrical Heater	765100047	1
47	Drainage Connector	06123401	1
48	Drainage hole Cap	06813401	3

Product

4 Supply Scope

S= Standard O= Optional F= Field Supplied

Name	Standard	Optional	Field Supplied
Owner's Manual for the Main Unit	√	/	/
Owner's Manual for the Control	√	/	/
2-way Valve	/	/	√
3-way Valve	/	/	√
Remote Temperature Sensor	√	/	/
Wired Controller	√	/	/
Communication Cable	√	/	/
Water Tank Temperature Sensor	√	/	/
Expansion Bolt	√	/	/
Solar System Water Pump	/	√	/
Solar System Flow Switch	/	√	/

Design and Selection

1 Installation Example

CASE 1: Connecting Under-floor Coil for Heating and Cooling

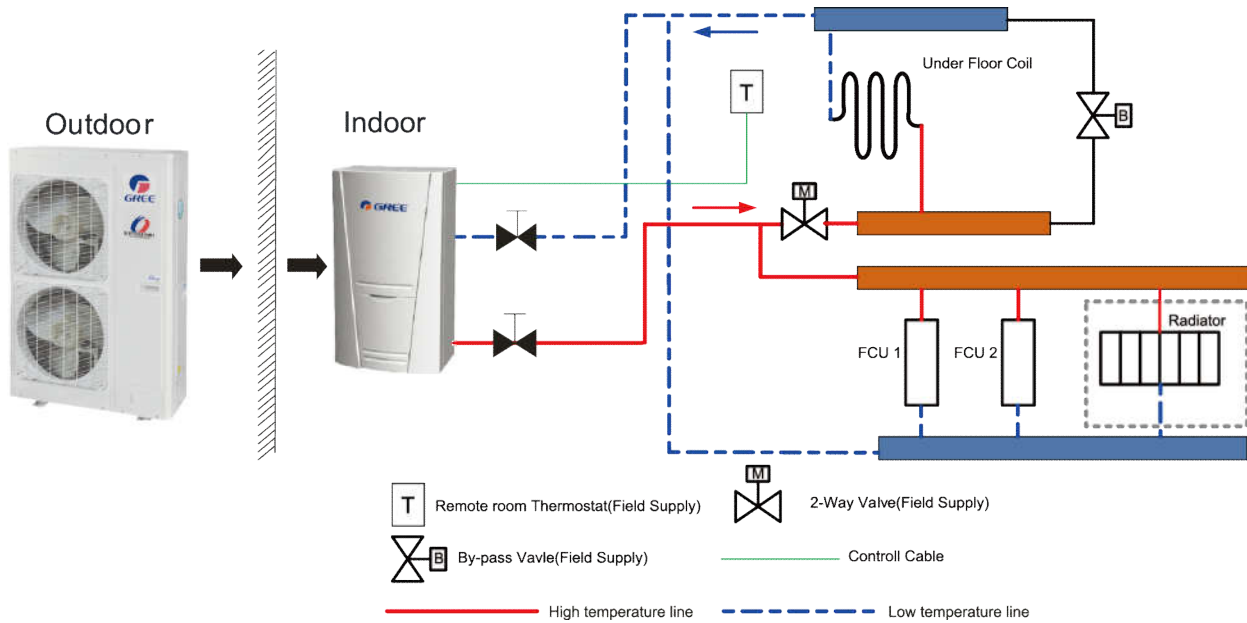

Note:

- The two-way valve is very important to prevent dew condensation on the floor and radiator while cooling mode;
- Type of thermostat and specification should be complied with installation of this manual;
- The bypass valve must be installed to secure enough water flow rate, and should be installed at the collector.

CASE 2: Connecting Sanitary Water Tank

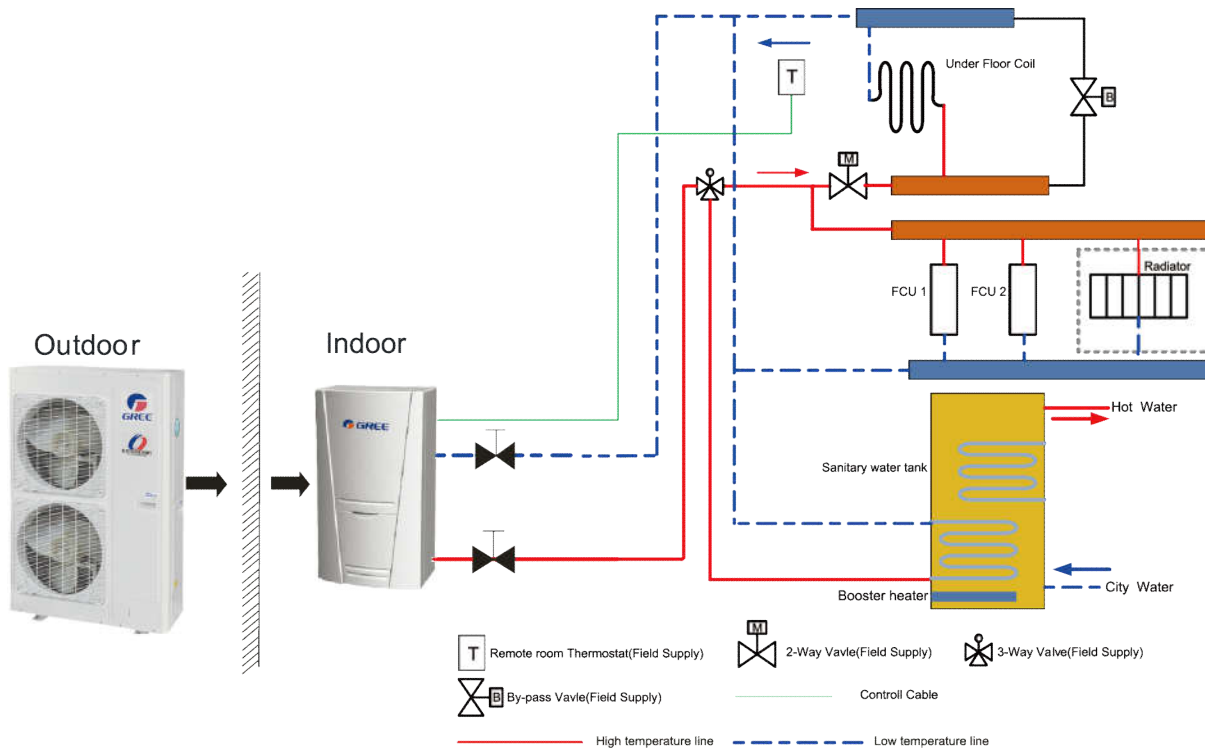

Note:

- In this case, three-way valve should be installed and should be complied with installation of this

Design and Selection

manual;

- Sanitary water tank should be equipped with internal electric heater to secure enough heat energy in the very cold days;

CASE 3 : Connecting Sanitary Water Tank and Heat Emitters for Heating and Cooling

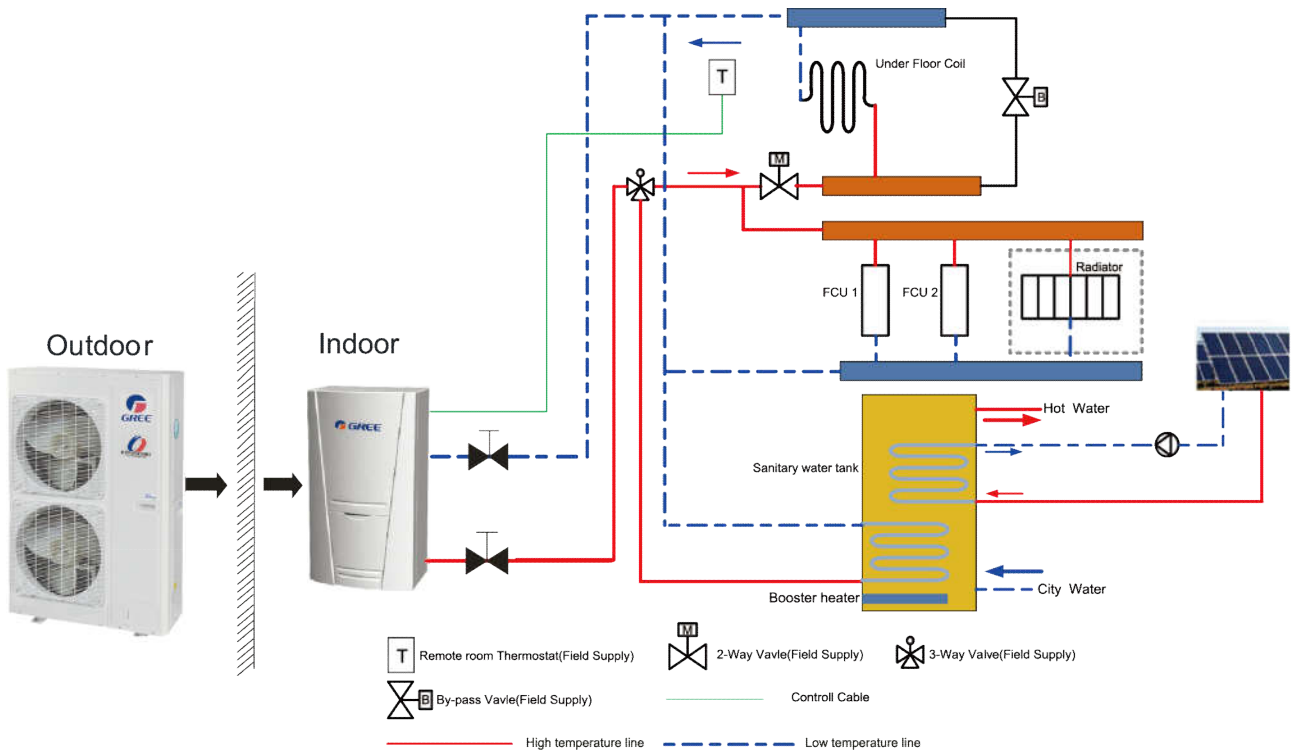

Two-way valve is very important to prevent dew condensation on the floor and radiator while cooling mode.

CASE 4 : Connecting Swimming pool system

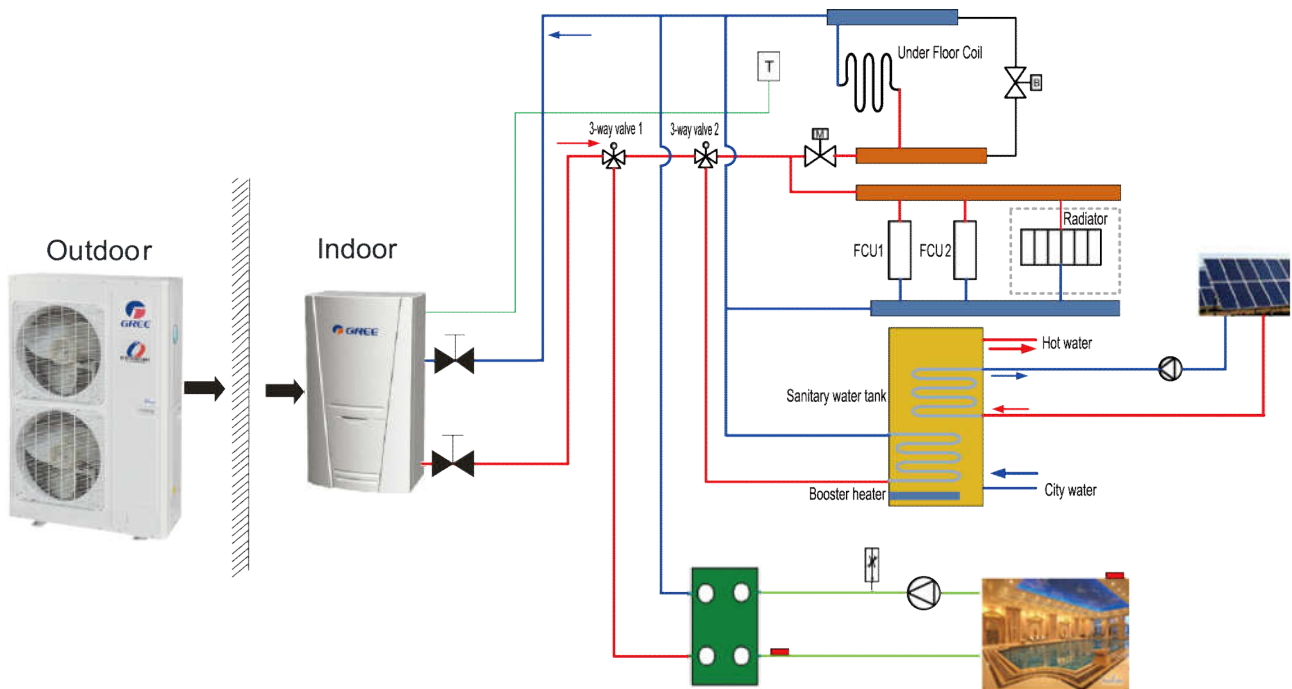

Note:

- ① Two-way valve is very important to prevent dew condensation on the floor and radiator while cooling mode.

- ② 3-Way valve 1 is controlled by user, while the pool pump is activated, 3-Way valve 1 switches to pool loop; while the pool pump is shut down, 3-Way valve 1 switches to under floor/FCU loop.
- ③ 3-Way valve 2 is automatic controlled by the unit, while running water heating mode, 3-Way valve 2 switches to water tank loop; while running cooling/heating mode, 3-Way valve 2 switches to under floor/FCU loop.

2 Model Selection

2.1 Speculations of Power Supply

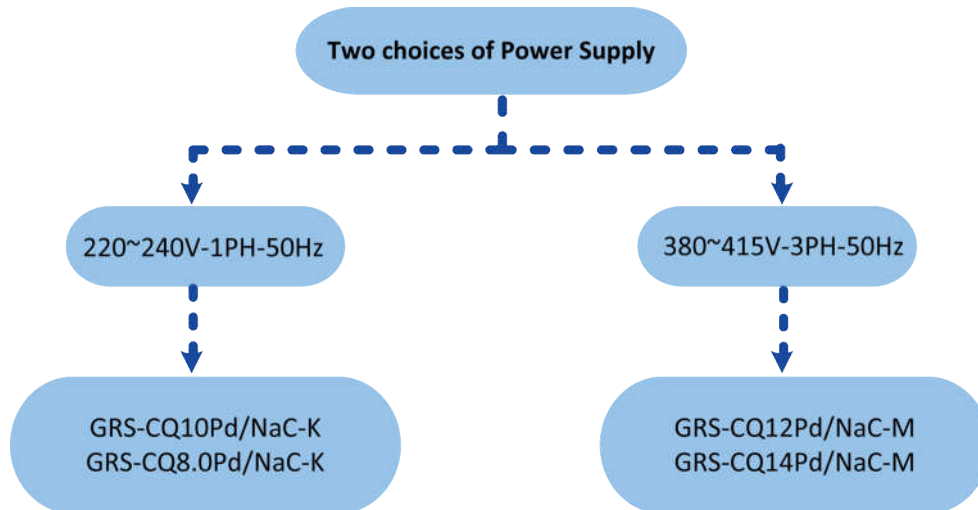

2.2 Operation Conditions

Capacities and power inputs are based on the following conditions (floor heating /cooling)	
a. Cooling conditions	b. Heating conditions
Indoor Water Temp 23°C/18°C;	Indoor Water Temp 30°C/35°C;
Outdoor Air Temp 35°C DB/24°C WB	Outdoor Air Temp 7°C DB/6°C WB
Capacities and power inputs are based on the following conditions (FCU or radiator)	
a. Cooling conditions	b. Heating conditions
Indoor Water Temp 12°C/7°C;	Indoor Water Temp 40°C/45°C;
Outdoor Air Temp 35°C DB/24°C WB	Outdoor Air Temp 7°C DB/6°C WB

2.3 Flowchart of Model Selection

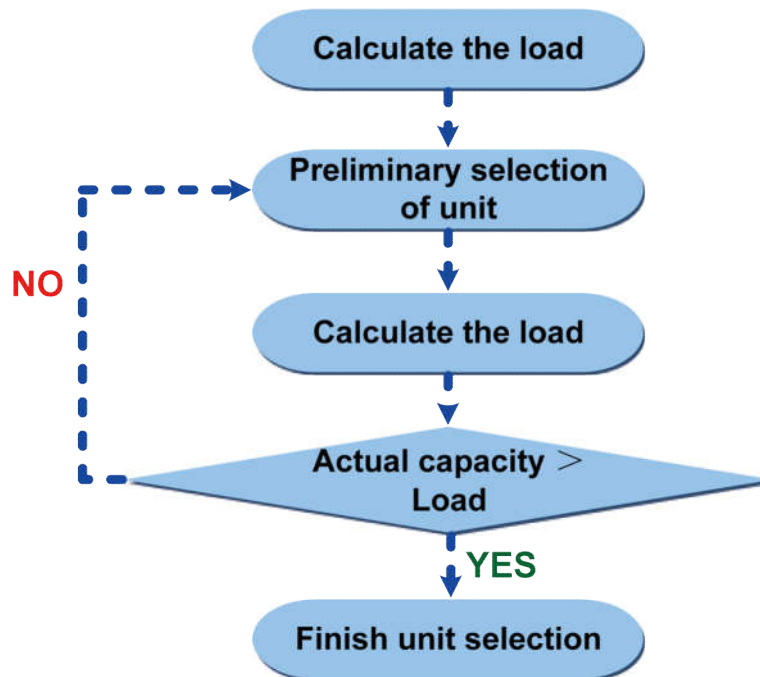

2.4 Design Principle

- ◆ Cooling: capacity of the unit \geq cooling load of the air conditioning
- ◆ Heating: capacity of the unit \geq $\max\{\text{heating load, floor heating load, water heating load}\}$
- ◆ Water Tank: it should be selected based on the sanitary outfit or quantity of users. Each unit can accommodate only one water tank.

3 Selection of the Underfloor Coils

3.1 Calculation of Unit Load for Floor Heating

Empirical Values of Floor Heating Load Per Square Meter

House W/m ²	
Dining Room	100~120
Mater Room	100~110
Guest Room	110~130
Study Room	90~110
Villa W/m ²	
Dining Room	110~140
Mater Room	100~120
Guest Room	100~130
Study Room	100~120

Note:

- Villas whose load is generally larger than the houses should take the value between the middle

and the maximum empirical values listed above.

- The top layer whose load is generally larger than the middle or bottom layer should take the maximum empirical value.
- The guest room whose load is generally much large should take the value between the intermediate and the maximum empirical values listed above.
- For those whose external walls or glass areas are large, it is recommended to take the load calculation.
- The heating load for the bathroom is generally 500W/room.

3.2 Selection of Tube Spacing of the Underfloor Coils

Tube spacing of the underfloor coils which will directly affect heat dissipation of the floor depends on the tube material, indoor design temperature, supply water temperature and floor material.

Heat Dissipation of Commonly Used Coils

(Tube material: PE-X, Indoor temperature:18°C, Average water temperature:45°C)

Floor Material	Thermal Resistance m ² ·K/W	Tube Spacing mm	Heat Dissipation W/m ²	Tube Spacing mm	Heat Dissipation W/m ²
Stone	0.02	200	147.0	150	159.8
Wood	0.075	200	111.2	150	117.8

The dissipated heat of the floor coil is larger than the load for the floor heating system; however the deviation cannot be larger than 10%.

3.3 Selection of Loop Quantity of Coils for Each Room

3.3.1 Type of Underfloor Coils

When selecting underfloor coils, we should consider both their comfortability and heating capacity. The most commonly used coils are as shown below.

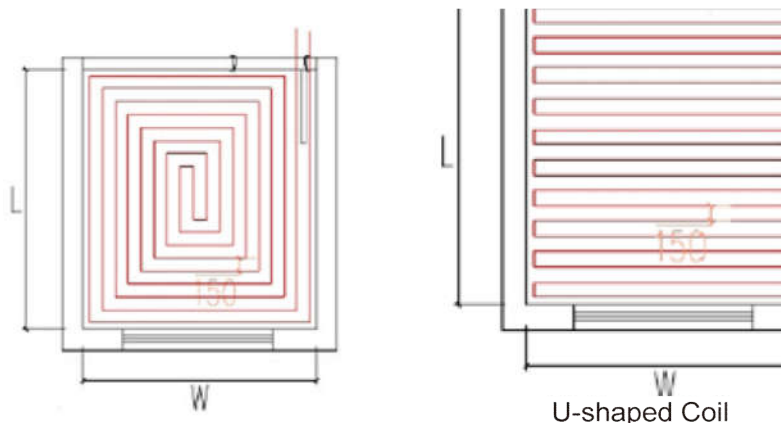

Square-shaped Coil (Recommended)

U-shaped Coil

Length of coils are calculated as below:

Square-shaped coil: $=L \cdot W / \text{tube spacing} = \text{area} / \text{tube spacing}$

U-shaped coil: $=L - 1 + L \cdot W / \text{tube spacing} = L - 1 + \text{area} / \text{tube spacing}$

The reason why the square-shaped coils are recommended is because they can keep even temperature distribution. Special demand can be met by adjusting the tube spacing.

Distance from the room to the water trap/collector should be estimated according to the actual

conditions of the project and generally should not exceed 30m.

3.3.2 Selection of Loop Quantity for Each Room

- ◆ Length of a single loop should not exceed 100m. If so, it should be divided into multiple loops.
- ◆ Area of a single loop=tube length×tube spacing=100m×150mm=15m²

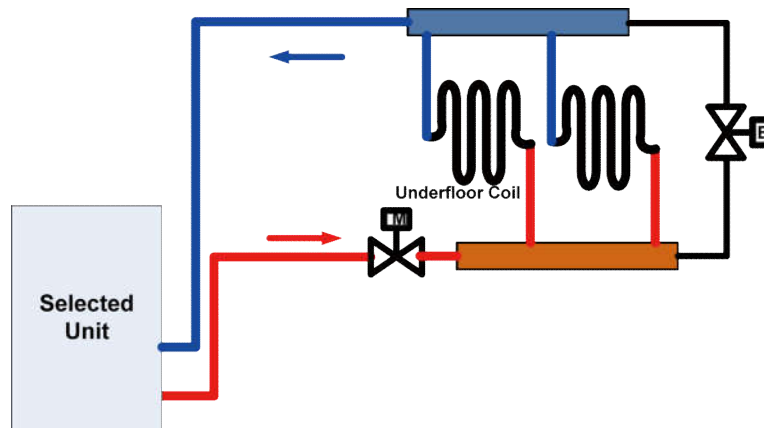

Length of underfloor coils is recommended to be within 100m and length of each branch should be kept the same to the most extent.

4 Quantity and Location of the Water Traps and Collectors

The water trap (collector) is a kind of device for distributing water for the water supply and return tubes.

4.1 Design Requirements on Loop Quantity for Circulation Water

- 1) One water trap (collector) is allowed for at most eight loops. When quantity of loops exceeds 12, then two traps (collectors) should be used, or it will cause uneven water distribution.
- 2) The maximum flow rate of the water trap (collector) should be less than 0.8m/s.
- 3) The inlet and outlet of each loop should be connected to the water trap (collector) and the inner diameter of the water trap (collector) should be or larger than that of the main water supply/return tube.

Calculation of loop quantity for circulation water can be done as per the formula below:

$$N=A/A1$$

N——loop quantity

A—— total floor heating area (unit: m²)

A1—— floor heating area per single loop (unit: m²)

Example for how to calculating the floor heating area per single loop: when the tube length is 120m, and tube spacing is 200mm, then the floor heating area per single loop is 120×0.2=24m².

- 4) One trap (collector) cannot be used for different floors, or it would cause uneven water distribution.

Design and Selection

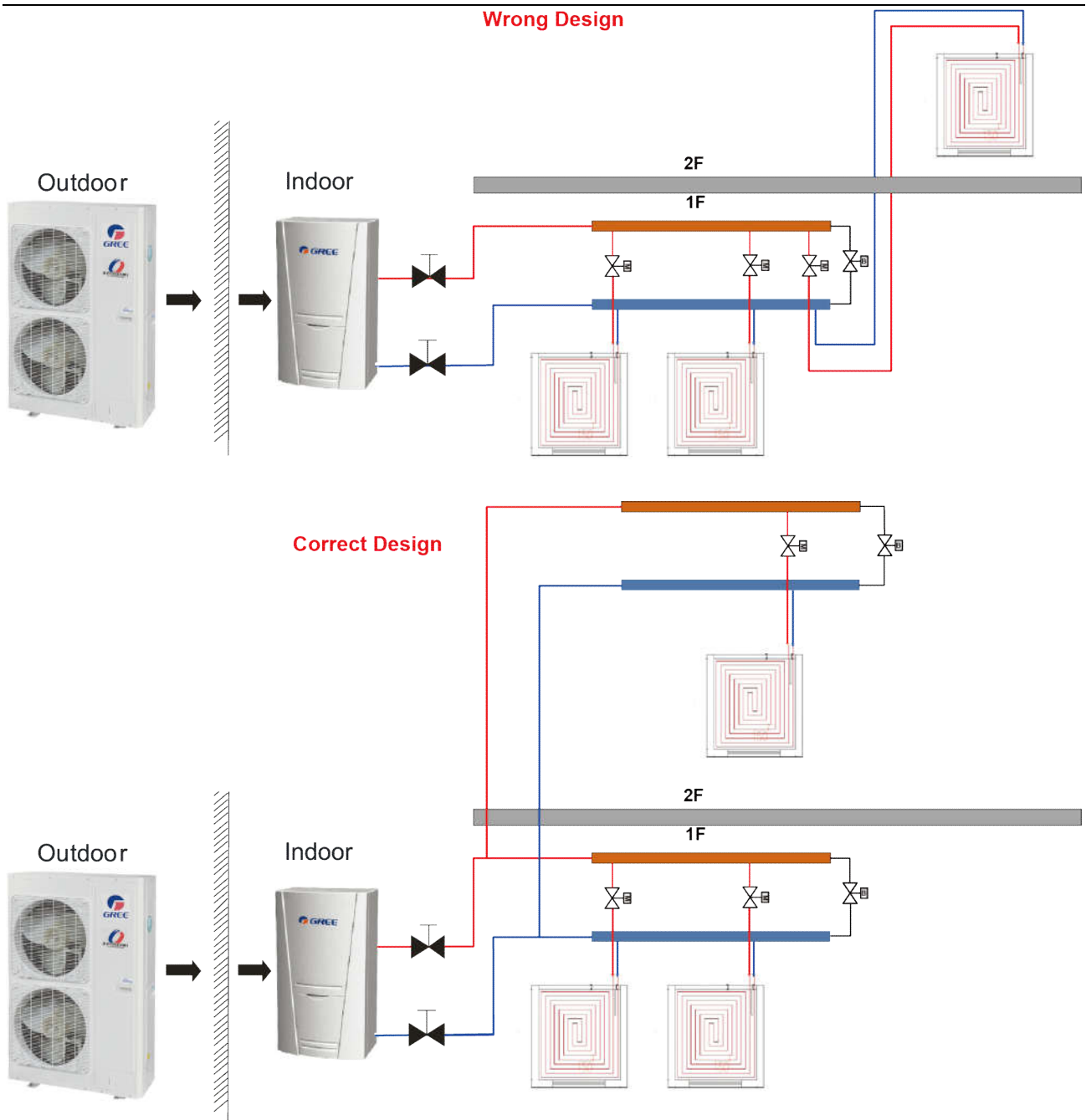

5) Distance between the unit and the water trap (collector) should be within 15m. If the distance exceeds 20m, then it is required to calculate the hydraulic power.

Design and Selection

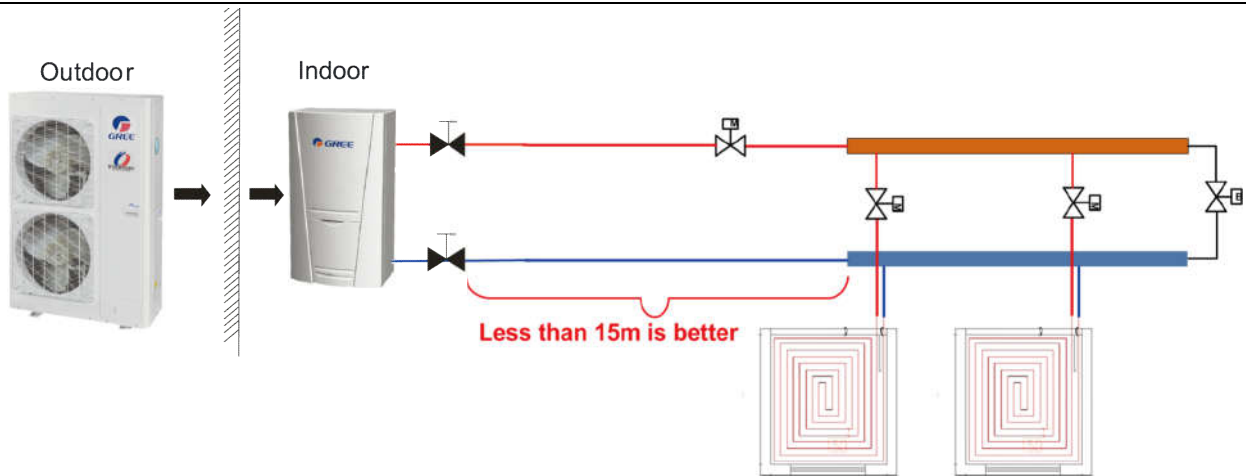

4.2 Requirements on Installation of the Water Trap (Collector)

- 1) The water trap (collector) should be installed on the wall or inside the special box. For housing constructions, it is generally installed in the kitchen.
- 2) The valve for the water trap (collector) should be installed horizontally and keep a distance of at least 300mm to the ground.
- 3) The water supply valve should be installed upstream of the water trap (collector) and the return valve should be installed downstream of the water trap (collector).
- 4) A filter is required upstream of the water trap (collector).

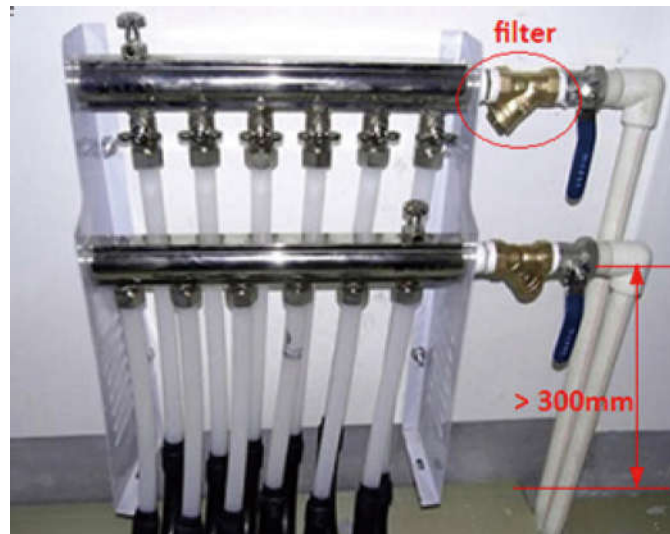

5 Section of FCU

5.1 FCU Type Selection

The air-water fan coil unit is optional for Versati units.

5.2 Matching of Capacity





Load of the FCU is better to be between 70%~120% of the Versati unit.

Notes:

- When load of the FCU is too small, the unit would start/stop frequently, which is adverse for oil return.

Design and Selection

- When load of the FCU is too large, the unit would always run under high frequency, which is unhelpful for energy conservation.

Type	Air Volume (m ³ /h)	Cooling Capacity (kW)	Heating Capacity (kW)	Static Pressure (Pa)	Appearance
Wall mounted type	166~1020	2.1~5.4	3.15~8.5	—	
Concealed ceiling type	213~2380	1.85~12.8	3.1~21	12, 30	
Floor ceiling type	213~2040	1.9~10.8	2.8~16.2	—	
Cassette type	480~1700	4.5~9	6.8~13.7	—	

6 Selection of the Water Tank

6.1 Specifications of the Water Tank

SXVD200LCJ/A-K	220~240V-1N-50Hz
SXVD300LCJ/A-K	A single coil with the electric heater is integrated, used for floor heating system
SXVD200LCJ2/A-K	220~240V-1N-50Hz
SXVD300LCJ2/A-K	Dual coils with the electric heater are integrated, used for floor heating system and the solar system
SXVD200LCJ/A-M	380~415V-3N-50Hz
SXVD300LCJ/A-M	A single coil with the electric heater is integrated, used for floor heating system
SXVD200LCJ2/A-M	380~415V-3N-50Hz
	Dual coils with the electric heater are integrated, used for floor heating system and the solar system

6.2 Volume Selection of the Water Tank

6.2.1 Selection Based on Water Consumption Per Capita

Building Type	Unit	Daily Water Consumption (L)	Water Temperature (°C)
House	Per person, Per day	40~80	60
Villa	Per person, Per day	70~110	60

6.2.2 Selection Based on Sanitary Utensils

Utensil Type	Daily Water Consumption (L)	Water Temperature (°C)
Bathtub, Sprinkler system (with shower)	150	40
Bathtub, Sprinkler system (without shower)	125	40
Shower	70~100	37~40
Wash Basin	3	30

6. 2.3 Selection of the Water Tank

Selection of the water tank should consider the flow rate of the shower head, duration of use per person and daily water consumption.

$$\text{Volume of the Water Tank} = \frac{t(\text{design temperature}) - t(\text{entering cold water temperature})}{t(\text{water tank temperature set point}) - t(\text{entering cold water temperature})} \cdot \text{consumption}$$

$$= \alpha \cdot \text{consumption}$$

t (design temperature): generally it is 60°C ;

t (entering cold water temperature): it differs for different regions;

t (water tank temperature set point): it is the target heating temperature of the water tank.

α: correction factor

Empirical Values for Volume Correction of the Water Tank

Duration of Use (min/Person) Flow Rate of the Shower Head (L/min)	10	15	20	25	30	40
	4	0.48	0.71	0.94	1.18	1.42
6	0.71	1.06	1.42	1.77	2.12	2.83
8	0.95	1.42	1.89	2.36	2.83	3.77
10	1.18	1.77	2.36	2.95	3.54	4.72
15	1.76	2.65	3.54	4.42	5.31	7.08

Empirical values are worked out under conditions of 80L consumption (per day per person), 8L/min flow rate of the shower head, and 10 minutes use duration per person.

7 Examples for Model Selection

7.1 General Introduction to the Example Project

For a two-floor house, there is a master room and a both room for each floor and both of them require floor heating. Other rooms use the heat pump for heating in winter. The master room covers 28m² and the both room covers 12m².

7.2 Heat Load Calculation

7.2.1 Load Calculation of a Single Floor

Room	Area	Heat Index (W/m ²)	Heat Load (W)
Master Room	28	82	2296
Bathroom	12	72	900
Total Load	2296+900=3196W		

7.2.2 Arrangement Design of the Underfloor System for A Single Floor

Assumed conditions: the floor is cement or ceramics, the normal external diameter of the heating pipe is 20mm, thickness of the stuffer is 50mm, thickness of PS foam insulation is 20mm, supply water temperature is 45°C, return water temperature is 35°C, indoor design temperature is 20°C.

$$\text{Average Temperature of the Heating Pipe} = (45+35)/2 = 40^\circ\text{C}$$

7.2.3 Arrangement Design of the Underfloor System for the Bath Room

Heat load of the bath room is 900W, heat dissipation per unit area is 75W/m², tube spacing of the heat pipe is 30mm, and heat loss is 25.4 W/m², then the total heat loss is:

$$25.4 \times 12 = 304.8\text{W}$$

Based on the heat load listed in the table above, the heating load for the bathroom is:

$$900 + 304.8 = 1204.8\text{W}$$

According to the formula $Q = C_p G \Delta T$, the flow rate of the heating pipe for the bathroom is:

$$G = \frac{Q}{C_p \Delta T} = \frac{1.2048\text{kJ}/1/3600\text{h}}{4.186\text{kJ}/(\text{kg} \cdot ^\circ\text{C}) \times 1000\text{kg}/\text{m}^3 \times (45-35)^\circ\text{C}} = 0.104\text{m}^3/\text{h}$$

If the outer diameter of the heating pipe is 20mm and thickness is 2mm, then the minimum flow for the heating pipe is:

$$G = \pi/4 D^2 v = 3.14/4 \times (20-2 \times 2)^2 \times 10^{-6} \times 0.25 \times 3600 = (0.18\text{m}^3)/\text{h}$$

It can be seen that the arranged piping system for the bathroom does not meet the technical requirement and must be used in common for the master room.

7.2.4 Arrangement Design of the Underfloor System for the Master and Bath Rooms

According to the calculation results, the total heat load for the master and bath rooms is 3196W, heat dissipation per unit area is 82W/m², tube spacing of the heating pipe is 300mm, and heat loss is 25.4 W/m², then the total heat loss is:

$$3196 + 1016 = 4212\text{W}$$

According to the formula $Q = C_p G \Delta T$, the flow rate is

$$G = \frac{Q}{C_p \Delta T} = \frac{4.212\text{kJ}/(1/3600\text{h})}{4.186\text{kJ}/(\text{kg} \cdot ^\circ\text{C}) \times 1000\text{kg}/\text{m}^3 \times (45-35)^\circ\text{C}} = 0.3622\text{m}^3/\text{h} > 0.18\text{m}^3/\text{h}$$

Loop quantity is 0.3622/0.18=2.012 and the round-off number is 2.

7.2.5 Check

A. Check for the flow rate

$$\frac{0.3622/2}{3.14 \times 0.008^2 \times 3600} = 0.2503\text{m/s}$$

Floor rate of each loop is within 0.25~0.5m/s and the system can run stably.

B. Check for the tube length

When the average tube spacing is 30mm, the required length of the heating pipe per square meter is 3.5m, length of total coils is 3.5×40=140 and length for each loop is 140/2=70.

It can be seen that the length for each loop is less than 120m and there it meets the design requirement.

C. Check for the ground average temperature

$$t_p = t_n + 9.82 \times (q_x/100) \times 0.969 = 20 + 9.82 \times (82/100) \times 0.969 = 28^\circ\text{C}$$

Upper Limits and Average Floor Temperature

Average Floor Temperature		
Area	Average Temperature	Maximum Temperature
Long-term Dwelling Area	24~26	28
Short-term Dwelling Area	28~30	32
Nobody Area	35~40	42

7.3 Model Selection

Heat demand for a single layer: 3196W

Heat loss for a single layer: 1016W

Total heat load for a single layer: 4212W

Total heat load of the building: 8424W

Capacity of the main unit should be larger than 8424W, so we can select: **GRS-CQ10Pd/NaD-K**

UNIT CONTROL

1 Integral Control Concept

1.1 Control Principle Diagram

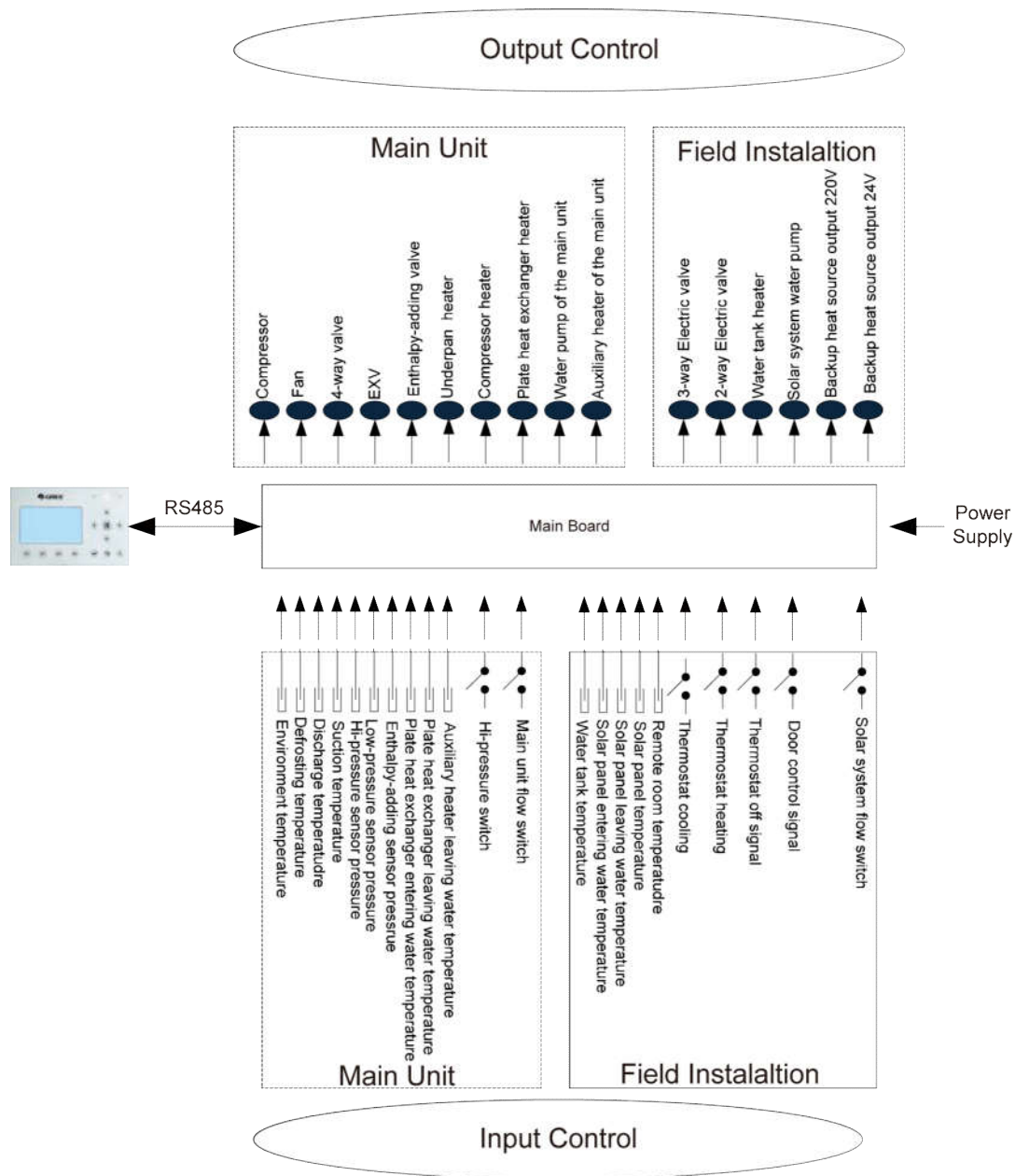

1. The environment temperature is detected by the sensor installed at fins of the finned heat exchanger, which is mainly used to control the initialization steps of the fan and the electrostatic expansion valve and also limit the maximum running frequency of the compressor. When this sensor fails, the main board will detect it and deliver this error message to the controller and then the unit will fail to start up or shut down.

2. The defrosting temperature is detected by the sensor installed at the defrosting pipes of the finned heat exchanger, which is mainly used to control defrosting. When this sensor fails at the heating or water heating mode, the compressor will stop and this error will be displayed at the controller. When it fails at the cooling mode, the compressor continues to run but this error will be displayed at the controller.

Unit Control

3. The discharge temperature is detected by the sensor installed at the discharge pipe of the compressor, which is mainly used for high discharge temperature protection. When this sensor fails, this error will be displayed at the controller, all loads except the water pump of the solar system and the electric heater of the water tank will stop. Then, the main unit will resume normal running when this error is eliminated.

4. The suction temperature is detected by the sensor installed at the suction pipe of the compressor, which is mainly used to control superheating degree. When this sensor fails, this error will be displayed at the controller, all loads except the water pump of the solar system and the electric heater of the water tank will stop. Then, the main unit will resume normal running when this error is eliminated.

5. The high pressure is detected by the sensor installed at the discharge pipe of the compressor, the low pressure is detected by the sensor installed at the suction pipe of the compressor, and the enthalpy-adding pressure is detected by the sensor installed at the enthalpy-adding pipe. The first one is mainly used for high pressure protection, the second one is mainly used to control defrosting, freeze protection and superheating degree, and all of three are used to together to control the intermediate pressure ratio of the compressor. When any of these sensors fails, it will be displayed at the controller, all loads except the water pump of the solar system and the electric heater of the water tank will stop. Among them, the water pump will stop 120 seconds later than the compressor. Then, the main unit will resume normal running when this error is eliminated.

6. The entering water temperature of the plate heat exchanger is detected by the sensor installed at the inlet pipe of the plate heat exchanger, which is mainly used for freeze protection. When this sensor fails, this error will be displayed at the controller but the unit will resume normal operation.

7. The leaving water temperature of the plate heat exchanger is detected by the sensor installed at the outlet pipe of the plate heat exchanger, which is mainly used for freeze protection at the water side. When this sensor fails, this error will be displayed at the controller and the unit will continues to operate.

8. The auxiliary heater leaving water temperature is detected by the sensor installed at the outlet pipe of the auxiliary heater, which is mainly used to control the leaving water temperature of the main unit. When this sensor fails, this error will be displayed at the controller, all loads except the water pump of the solar system and the electric heater of the water tank will stop (the 2-way electric and 3-way electric valve will be closed).

9. The hi-pressure switch is used to judge the system pressure. When the pressure is too high, this switch will disconnect and the unit will shut down.

10. The flow switch of the main unit is mainly used to judge the water flow. When the flow rate is too low, this switch will disconnect, all loads except the water tank heater and the water pump of the solar system will stop. This error will be displayed at the controller and will be unrecoverable. The unit can restart only when it is repowered on and this error does not be displayed again.

Items from 1~10 listed above are control parameters input by the main unit.

11. The water tank temperature is detected by sensors immersed inside the water tank. These sensors can be divided into two groups. Group 1 is used to control the water tank temperature and group 2 is used to display the water tank temperature. When group 1 fails at the heating mode, this error will be displayed at the controller, and all loads except the water pump of the main unit will stop. When group 2 fails, this error also will be displayed at the controller but the unit continues normal operation.

12 The leaving and entering water temperature of the solar panel and also the solar panel temperature are detected by sensors installed at the inlet pipe, outlet pipe and solar panel of the solar system respectively. Theses sensors are mainly used to control the water pump of the hot water of the solar system. When the entering water temperature sensor fails, this error will be displayed at the controller and the unit continues normal operation. When other two sensors fail, this error also will be

Unit Control

displayed at the controller and the water pump of the solar system will stop.

13. The remote room temperature is detected by the sensor installed at the room, which is mainly used to control the input capacity of the compressor through room temperature setting. When the main unit is controlled through the room temperature and this sensor fails, all loads except the water pump of the solar system and the electric heater of the water tank will stop. However, when the main unit is controlled through the leaving water temperature, if this sensor fails, this error will be displayed but the main unit will resume normal operation.

14. Only when the control function of the thermostat has been activated through the wired controller, then the thermostat can switch run modes among cooling, heating and shutdown, otherwise, the unit will run as per the run mode set by the wired controller.

15. The gate control function can be set to be "On" or "Off" at the function setting page of the wired controller. When this function has been activated and it is detected that the gate control card has been drawn out, the unit will shut down and will tell any key operation of the controller is invalid. Then, if it is detected that the gate control card has been inserted in, the unit will resume normal operation.

16. The flow switch of the solar system is mainly used to judge the water flow. When the flow rate is too low, the flow switch will disconnect and immediately the water pump of the solar system will stop. This error will be displayed at the controller and is unrecoverable. When this error is cleared, upon power on again, the unit will restart.

Items 11~16 are control parameters input by the field installed equipment.

1.2 Control Flowchart

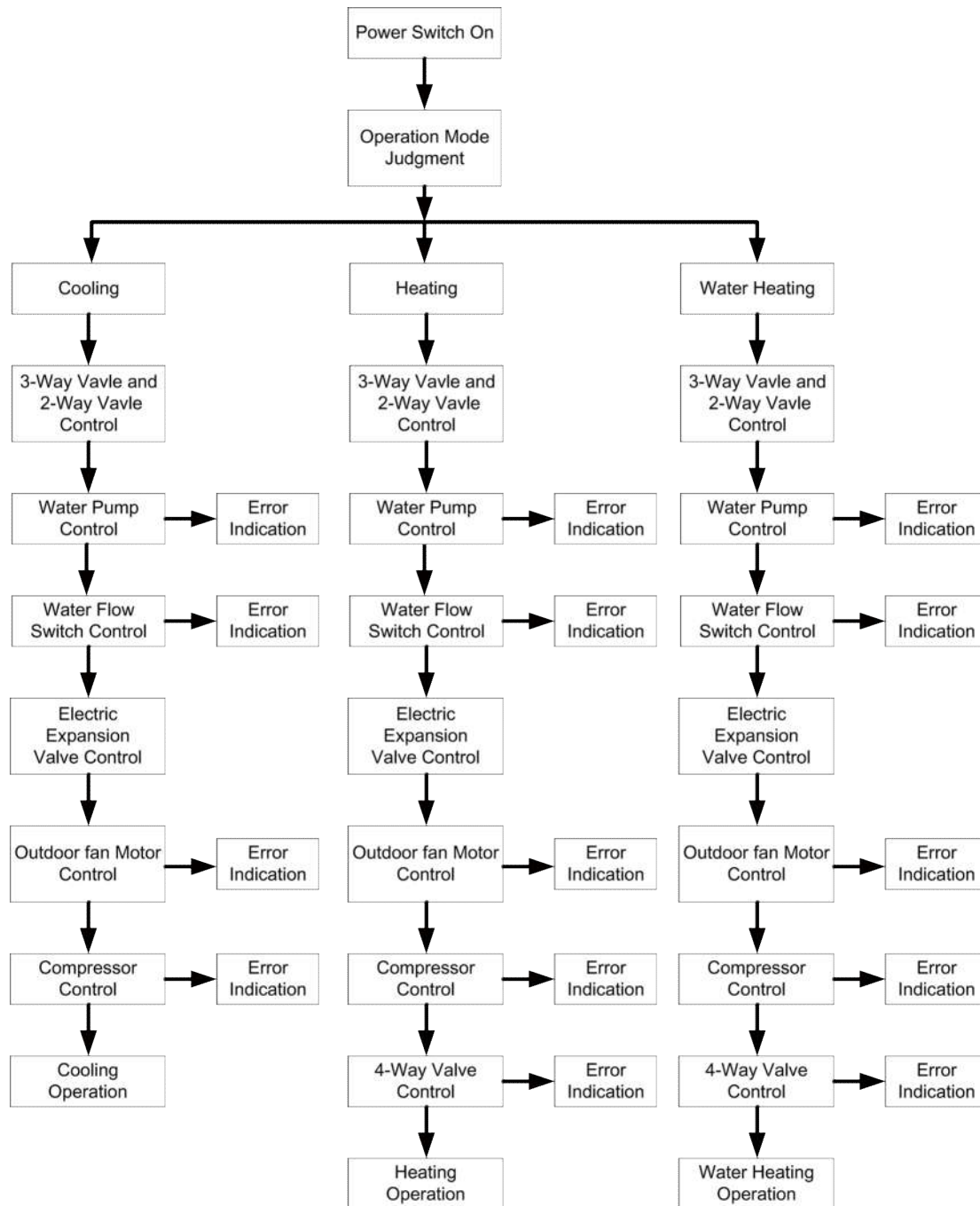

2 Main Control Logics

2.1 Cooling

2.1.1 Control to the Compressor

When the unit is controlled by the leaving water temperature, the operating frequency of the compressor will be adjusted by the temperature difference in the way that it increases as the temperature difference goes up and it decreases as the temperature difference goes down. (Temperature difference= actual leaving water temperature-leaving water temperature set point).

2.1.2 Freeze Protection

When it is detected that the leaving water temperature of the plate heat exchanger is lower than the freeze protection temperature, the compressor will drop its operating frequency until it reaches the minimum operating frequency. Then if it is still detected that the leaving water temperature is lower than the freeze protection temperature, the main unit will stop as per the shutdown frequency but the water pump keeps normal operation.

When it is detected that the leaving water temperature of the plate heat exchanger is equal to or larger than the freeze protection withdrawing temperature, freeze protection will exit. At this point, once the compressor has stopped for three minutes and conditions for startup have been satisfied, the compressor will run for cooling.

2.2 Heating

2.2.1 Control to the Compressor

When the unit is controlled by the leaving water temperature, the operating frequency of the compressor will be adjusted by the temperature difference in the way that it increases as the temperature difference goes up and it decreases as the temperature difference goes down. When the compressor reaches the minimum frequency but the temperature frequency is still quite large, the unit will shut down (temperature difference= actual leaving water temperature-leaving water temperature set point).

2.2.2 Over-temperature Protection

When the compressor is running and it is detected that the leaving water temperature of the auxiliary electric heater is higher than the over-temperature protection temperature, the compressor will lower its frequency to the minimal. Then if it is still detected that the leaving water temperature of the auxiliary electric heater is higher than the over-temperature protection temperature, all loads except the water pump of the main unit and the 4-way valve will stop. Over-temperature protection will exit until the leaving water temperature of the auxiliary electric heater is lower than the over-temperature withdrawing temperature. After that, the unit will resume normal operation.

2.2.3 Control to the Auxiliary Electric Heater

When the auxiliary electric heater is deactivated through the wired controller, it will never come into operation. When it is activated, it will run based on the outdoor temperature.

2.3 Water Heating

Water heating can be achieved by either the solar system or the main unit (heat pump).

2.3.1 Water Heating by the Main Unit

1) When the outdoor temperature is out of the operation range, the compressor will not start, and water heating will be done by the water tank heater.

2) When the outdoor temperature is within the operation range, water heating will be done by the main unit. The output frequency of the compressor will be adjusted by the difference between the water tank temperature set point and the actual water tank temperature.

3) Control to the Auxiliary Electric Heater

a. when the water tank temperature set point is lower than the maximum value of the water heating range of the main unit, the auxiliary electric heater of the main unit will run depending on the temperature difference, and the water tank keeps shut-down.

b. when the water tank temperature set point is higher than the maximum value of the water heating range of the main unit but the actual water tank temperature is lower than the maximum value of the

water heating range of the main unit, the auxiliary electric heater of the main unit will run depending on the temperature difference. If the actual water tank temperature is higher than the maximum value of the water heating range of the main unit, the water tank heater will start. At any time, only one between the auxiliary electric heater and the water tank heater is allowed to run.

2.3.1.1 Over-temperature Protection for Water Heating

When the compressor is running, if it is detected that the leaving water temperature of the auxiliary electric heater of the main unit is higher than the over-temperature protection temperature, the compressor will lower its operating frequency until it reaches the minimal operating frequency. At this point, if it is still detected that leaving water temperature is still lower than the over-temperature protection, all loads except the water pump of the main unit and the 4-way valve will stop. Over-temperature protection will exit when the leaving water temperature is lower than the over-temperature protection temperature. Then, the main unit will resume normal operation.

2.3.2 Water Heating by the Solar System

When the solar water heating system is equipped but temperature difference (it is the difference of solar panel temperature and the actual water tank temperature) for startup is not satisfied, the water pump of the solar system will not start. When the temperature difference is satisfied, the water pump will start. However, when it is detected that the water tank temperature reaches the set point, or the entering/leaving water temperature difference of the solar panel is too small, then this water pump will stop running.

2.4 Shutdown

There are three kinds of shutdown conditions: normal shutdown, shutdown with some error, shutdown for protection

Shutdown sequence: for normal shutdown, the compressor lowers its frequency firstly to the minimum value, while for shutdown with some error or for protection, the compressor will stop directly. Then, the electrostatic expansion valve turns to the maximum opening angle; the fan stops after the compressor has stopped; the water pump of the main unit stops after the compressor has stopped; the electrostatic expansion valve turns the maximum opening angle to the fixed opening angle.

During shutdown under the heating and water heating modes, the 4-way valve will be powered off after the compressor has stopped.

For shutdown owing to some error (except the communication error) or protection, the 4-way valve will keep the power-on status.

For shutdown owing to communication between the unit and the wired controller, the 4-way valve will be powered off some timer later.

For shutdown with some error or for protection, the electrostatic expansion valve will keep the maximum opening angle.

2.5 Control to the Compressor

When the unit is controlled by the leaving water temperature, the output frequency of the compressor is adjusted by the difference between the actual water temperature and the leaving water temperature set point. When the unit is controlled by the room temperature, the output frequency of the compressor is adjusted by the difference between the actual room temperature and the room temperature set point.

2.6 Control to the Fan

Under the cooling mode, the operating frequency of the fan is adjusted according to pressure at the

high pressure side. Under the heating or water heating mode, the operating frequency of the fan is adjusted according to the pressure at the low pressure side. During defrosting, the fan stops and resumes operation when defrosting ends up.

2.7 Control to the 4-way Valve

The 4-way valve always keeps on under the cooling mode and will off after the compressor starts up under the heating or water heating mode. When the unit comes into defrosting, the 4-way valve will be on and resume the off status when defrosting ends up. For shutdown under the heating mode, the 4-way valve will be closed after the compressor stops.

2.8 Control to the Water Pump

The water pump firstly will run at the initialized speed and then adjust the speed according to the entering/leaving water temperature difference. When the temperature difference is large, the fan runs at the high speed. When the temperature difference is small, the fan runs at the low speed.

2.9 Control the Electrostatic Expansion Valve

There are two electrostatic expansion valves for two-stage throttling control. The opening angle of the first-stage electrostatic expansion valve is adjusted based on the ratio of readings of the high-pressure sensor, low-pressure sensor and enthalpy-adding sensor. The opening angle of the second-stage is adjusted based on the suction superheating degree.

2.10 Protection Control

(1) Compressor Low-pressure Protection

When it is detected continuously that pressure at the low side is too low, then low-pressure protection will occur and this error will be displayed at the controller, all loads act as per the shutdown sequence. This error is unrecoverable and can be cleared unless repowered on.

(2) High Discharge Temperature Protection

When it is detected continuously that the discharge temperature is higher than the recoverable temperature, the electrostatic expansion valve will turn to the maximum opening angle with large step until the discharge temperature is lower than the recoverable temperature. However, if this condition remains, the compressor will restrict the frequency output or lower its frequency three times. At any time, if it is detected that the discharge temperature is higher than the set point for protection for three seconds, the compressor will stop and the unit comes into high discharge temperature protection.

(3) Refrigerant Loss Protection

When the unit receives the "On" demand (through On/Off key operation or automatic freeze protection), it will immediately detect the temperature of the high-pressure sensor and the environment temperature. If the temperature of the high-pressure sensor is lower than the set point, this error will be displayed with the error indicating LED flashing. In this case, the unit is not allowed to start up unless this error does not exit. Once the compressor starts up, the system will no longer detect refrigerant loss protection.

(4) Water Pump Protection

When it is detected continuously for three seconds that the unit comes into water pump overload protection, then all loads except the water pump of the solar system and the auxiliary electric heater of the water tank will stop. Three minutes later, all loads resume normal operation. When it is detected three times within 60 minutes that the unit comes into water pump overload protection, this error will be

Unit Control

displayed and is unrecoverable. The unit is allowed to restart only after the unit is shut down manually and this error is cleared.

(5) Compressor Hi-pressure Protection

In any case, when it is detected that the high-pressure switch acts, the unit will come into high-pressure protection three seconds later. This protection is unrecoverable.

(6) Flow Switch Protection

In any case, when it is detected that the flow switch of the main unit disconnects, then all loads except the water pump of the solar system and the auxiliary electric heater of the water tank will stop. This protection is unrecoverable. The unit is allowed to be restart only after this error is cleared and the unit is repowered on.

(7) Communication Error

When the indoor unit main board or drive board does not receive correctly any data from the unit main board, all loads will stop and vice versa.

3 Controller

3.1 External View

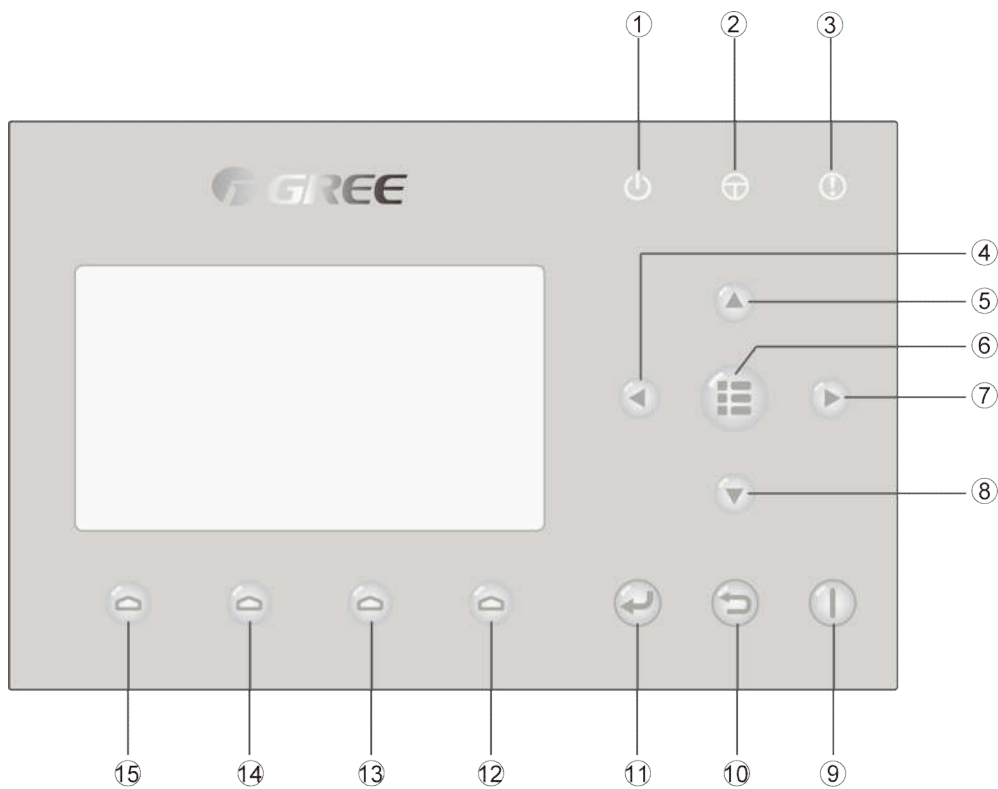













(This effect drawing is just for reference)

3.1.1 Keys & Indicating LEDs

No.	Symbol	Name	Functional Description
①		Running indicating LED (green)	It will light on/off when the unit is turned on/off.
②		Power indicating LED (yellow)	It will light on/off when the unit is powered on/off.

Unit Control

③		Error indicating LED (red)	It will light on when some fault occurs.
④		Left key	It is intended to move the cursor left.
⑤		Up key	It is intended to modify the setting state or value of the selected parameter.
⑥		Menu key	It is intended to call out the main menu or back to the homepage.
⑦		Right key	It is intended to move the cursor right.
⑧		Down key	It is intended to modify the setting state or value of the selected parameter.
⑨		ON/OFF key	It is intended to turn on or off the unit.
⑩		Cancel/Return key	It is intended to go to the higher level menu.
⑪		OK key	It is intended to save the setting or go to the submenu.
⑫		Function key no. 4	It is intended to perform different functions at difference pages.
⑬		Function key no. 3	
⑭		Function key no. 2	
⑮		Function key no. 1	

3.1.2 Standby Page and Homepage

Standby Page

8:30	2013/4/24	Wednesday
Mode	Auxiliary func.	Error state
Off	No	Yes
T-water out	T-outdoor	Key lock
40 °C	20 °C	No

Home Page

Unit Control

8:30	2013/4/24	Wednesday	
Mode	Auxiliary func.	Error state	
Off	No	Yes	
T-water out	T-outdoor	Key lock	
40 °C	20 °C	No	
FUNC.	PARA.	VIEW	GEN.

No.	Item	Functional Description
1	Mode	It is intended to access to the actual running mode.
2	Auxiliary Func.	It indicates the auxiliary function.
3	Error state	It indicates if there is any error.
4	T-water out	It indicates the actual leaving water temperature.
5	T-outdoor	It indicates the actual outdoor environment temperature.
6	Key lock	It indicates if the key lock is activated or deactivated.
7	FUNC.	It is intended to access to the function setting page.
8	PARA.	It is intended to access to the parameter setting page.
9	VIEW	It is intended to access to the view page.
10	GEN.	It is intended to access to the general setting page.

Note:

it includes the “Sanitize mode”, “Quiet” mode, “Auto” mode, “Floor debug” mode, “Emergen. mode”, “Holiday mode”, “Forced Cooling” mode, “Forced Heating” mode, and “Debug” mode.

3.2 Operation Instructions

3.2.1 On/Off

It is intended to turn on/off the unit.



[Operation Instructions]







At the homepage, by pressing the **ON/OFF** key , the unit will be turned on/off.

When the unit is **ON**, the green indicating LED  located at the upper right of the control will light

Unit Control

on. When the unit is **OFF**, the green indicating LED  will light off.

[Notes]

- ① The unit is defaulted to be **OFF** when energized for the first time.
- ② The **ON/OFF** key operation works only at the home page and the standby page.
- ③ When the “**Holiday mode**” or the “**Emergen.mode**” is activated, the **ON/OFF** key  operation will become ineffective.
- ④ When the “**Forced Heating**” or “**Forced Cooling**” is activated, it will be deactivated by pressing the “**ON/OFF**” key , and then press the **ON/OFF** key  again to start the unit.
- ⑤ **ON/OFF** operation will be memorized by setting “**On/off Memory**” to be “**On**” at the “**GEN.**” setting page. That is, in case of power failure the unit will resume running upon power recovery. Once “**On/off Memory**” is set to be “**Off**”, in case of power failure the unit will keep “**Off**” upon power recovery.
- ⑥ At the home page, the **ON/OFF** key  is intended to turn on/off the unit if applicable. The Function keys no.1 to no.4 are corresponding to “**FUNC.**”, “**PAPA**”, “**VIEW**” and “**GEN.**” setting pages respectively.
- ⑦ At the standby page, the Menu key  is used to back to the homepage, the **ON/OFF** key  is used to turn on/off the unit if applicable, and all other key operations are ineffective.
- ⑧ The control will return automatically to the homepage where there is no any key operation in 10 consecutive minutes.

3.2.2 Function Setting

It enables the user to set each function.

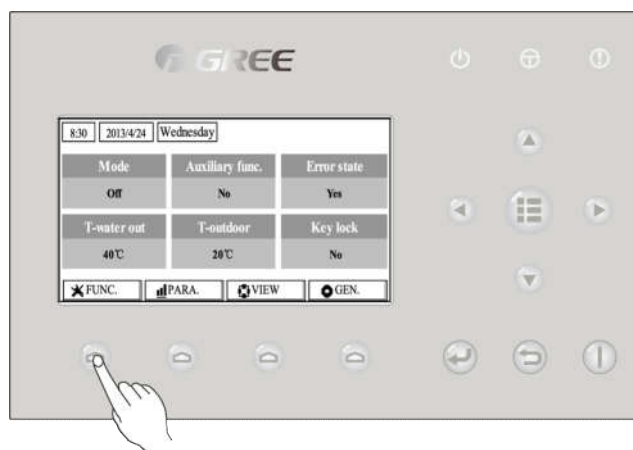









[Operation Instructions]

1. At the homepage, by pressing the Function key no. 1 , the control will access to the **FUNCTION** page 1, as shown in the figure below.

Unit Control

8:30	2013/4/24	Wednesday	FUNCTION
Mode	Ctrl. state	Fast hot water	
Heat	T-room	Off	
T-water ctrl.	Cool+hot water	Heat+hot water	
Low temp.	Cool	Heat	
		↑ Last	↓ Next

FUNCTION page 1

2. At the **FUNCTION** page, by the Right/Left key   , the desired function option can be selected, and by the Up/Down key   , the setting of the current function option can be modified. The function key no. 3  or no. 4  can be used for switch pages. After the setting is finished, by pressing the Menu key  , the control will back to the homepage, or by pressing the Return key  the control will back to the higher level menu.

[Notes]

- ① Move the cursor to the desired option and **“Enter”** will be displayed at the lower left side of the LCD, reminding you that you are allowed to access to the submenu by pressing the OK key  .
- ② At the **FUNCTION** page, when the setting of some function option is changed and needs to be memorized, then in case of power failure it will be saved automatically and resume upon power recovery.

Function Settings

No.	Full Name	Displayed Name	Range	Default	Remarks
1	Running mode setting	Mode	Cool Heat Hot water Cool+Hot water Heat+Hot water	Heat	When the water tank is unavailable, then only “Cool” and “Heat” are included in the range.
2	Control state	Ctrl. state	T-water out /T-room	T-water out	“T-Room” is available only when “Remote Sensor” is set to “WITH”.
3	Fast hot water	Fast hot water	On/Off	Off	When the water tank is unavailable, this function will be reserved, and the LCD will display ‘Reserved’.
4	Water out temperature control	T-water ctrl.	High temp. /Normal temp.	Normal temp.	/

Unit Control

5	Cool+hot water	Cool+hot water	Cool/Hot water	Cool	When the water tank is unavailable, this function will be reserved, and the LCD will display 'Reserved'.
6	Heat+hot water	Heat+hot water	Heat/Hot water	Heat	When the water tank is unavailable, this function will be reserved, and the LCD will display 'Reserved'.
7	Quiet mode	Quiet mode	On/Off	Off	/
8	Quiet timer	Quiet timer	On/Off	Off	/
9	Weather-dependent mode	Weatherdepend	On/Off	Off	/
10	Holiday release	Holiday release	On/Off	Off	/
11	Disinfection	Disinfection	On/Off	Off	When the water tank is unavailable, this function will be reserved, and the LCD will display 'Reserved'.
12	Weekly timer	Weekly timer	On/Off	Off	/
13	Clock timer	Clock timer	On/Off	Off	/
14	Temperature timer	Temp. timer	On/Off	Off	/
15	Solar kit	Solar kit	On/Off/Timer	Off	When the water tank is unavailable, this setting will be reserved. If it is set to "On", the solar kit will function no matter if the timer is activated or not; if it is set to "Off", the solar heating function is unavailable; if it is set to "Timer", the solar kit can function when the timer has been activated.
16	Floor debug	Floor debug	On/Off	Off	/
17	Emergency mode	Emergen. mode	On/Off	Off	/
18	Holiday mode	Holiday mode	On/Off	Off	/
19	Thermostat	Thermostat	Air/Without/ Air+hot water	Without	This setting cannot be changed from "Air" to "Air+hot water" directly but via "Without" this option and the unit will go to Without status. Meanwhile, the control will send out "Without" command for consecutive 40 seconds (it is longer than the communication error, and the "On" command can be performed only when 40 seconds have been expired. When it set to "Air+hot water", "hot water" can be performed even though the thermostat is off.

Unit Control



20	Assistant heater	Assis. Heater	1/2/Off	Off	/
21	Other heater	Other heater	With/Without	Without	/
22	Chassis heater	Chassis heater	On/Off	On	/
23	Tank heater running	Tank heater	With/Reserved	Reserved	If the water tank is available, this setting is "With". If the water tank is unavailable, this setting is "Reserved".
24	Plate heat exchanger heater	Plate heater	On/Off	On	
25	Solar kit-antifreeze	Solar antifre	On/Off	Off	
26	Water tank	Water tank	With/Without	Without	/
27	Tank sensor	Tank sensor	1/2	2	When the water tank is unavailable, this function will be reserved. and the LCD will display 'Reserved'.
28	Solar heater	Solar heater	With/Without	Without	/
29	Floor config	Floor config	With/Without	With	If it is set to "With", the control is defaulted to be "Normal temp". For "Without", it is "High temp". This setting is unavailable when the unit is OFF.
30	Radiator config	Radia config	With/Without	Off	
31	FCU	FCU	With/Without	Without	
32	Remote sensor	Remote sensor	With/Without	Without	When it is set to "Without", the "Control state" will be automatically changed to "T-water out".
33	Air removal	Air removal	On/Off	Off	/
34	Address	Address	[0~12] [127~253]	0	/
35	Gate-Controller	Gate-Ctrl.	On/Off	Off	/



3.2.2.1 Mode

It enables the user to select the run mode of the unit. When the water tank is not prepared, then only **Cool** and **Heat** modes are available. When the water tank has been prepared and **Water Tank** is set to "With" through the wired controller (see Section 2.2.26 for more details), then **Cool**, **Heat**, **Hot water**, **Heat + hot water**, and **Cool + hot water** modes are available. In this case, **Heat + hot water** or **Cool + hot water** can be given priority. (see Section 2.2.5 and 2.2.6 for more details), which is the default setting before delivery.

[Operation Instructions]

At the equipment OFF state, access to the **FUNCTION** page and then move through the Left/Right

key   the cursor to the "**Mode**" whose characters will be reversed, then press the Up/Down

key   to modify its setting.

[Notes]

- ① The “**Heat**” mode is defaulted when the unit is energized for the first time.
- ② The running mode is allowed to be changed only when the unit is not in operation. If it is done with the unit being on, a window will pop up, warning “**Please turn off the system first**”.
- ③ When the water tank is disabled, only the “**Heat**” or the “**Cool**” mode is allowed.
- ④ When the water tank is enabled, “**Cool**”, “**Heat**”, “**Hot water**”, “**Cool+hot water**”, “**Heat+hot water**” is allowed.
- ⑤ For the heat pump, the “**Cool**” mode is allowed; for the heating only unit, “**Cool+ Hot water**” and “**Cool**” are unallowable.
- ⑥ This setting can be memorized upon power failure.

3.2.2.2 Control State (Ctrl. state)

It enables the user to configure the control state to leaving water temperature or room temperature.

[Operation Instructions]

Go to the **FUNCTION** page and locate “**Ctrl. state**”, then, configure it through the Up/Down key



[Notes]

- ① If “**Remote sensor**” is set to “**With**”, “**T-out water**” and “**T-room**” are available. While if “**Remote Sensor**” is set to “**Without**”, only “**T-out water**” is selectable.
- ② This setting will be memorized upon power failure.

3. 2.2.3 Fast Hot Water

When hot water is needed urgently, this function can be configured to be “**On**”, In this case, the heat pump and the water tank heater will work together to generate sanitary hot water in a quickest way.

[Operation Instructions]

Go to the **FUNCTION** page and locate “**Fast hot water**”, then, configure it through the Up/Down key



, “**On**” or “**Off**”.

[Notes]

- ① It works only when “**Water tank**” is set to “**With**”.
- ② This setting will be memorized upon power failure.

3. 2.2.4 T-water Ctrl (Water Temperature Control for Heating)

There are two options for the leaving water temperature control, high-temperature water circulation (**High temp**) and normal-temperature water circulation (**Normal temp**). When “**Floor config**” is set to “**With**” (see 2.2.29), then the leaving water temperature control is defaulted to be “**Normal temp**” and cannot be changed. When “**Floor config**” is set to “**Without**” (see 2.2.29), no matter either “**FCU config**”(see 2.2.31) or “**Radia config**”(see 2.2.30) is set to “**With**”, the leaving water temperature is defaulted to be “**Hihg temp**”and cannot be changed.

“**Floor config**”, “**FCU config**”, and “**Radia config**” all can be configured to be “**With**”. However, as long as “**Floor config**” is configure to be “**With**”, only “**Normal temp**” is available.

[Operation Instructions]

Go to the **FUNCTION** page and locate “**T-water ctrl.**”, then,check the water control is “**Normal temp**” or “**Hihg temp**”.

[Notes]

- ① When this setting is changed, the following parameters will return to the default values.

Unit Control

Full Name	Displayed Name	Default
Water out temperature for heating	WOT-Heat	45°C/113°F[High] 35°C/95°F[Normal]
Upper limit water-out temperature at the weather-dependent mode for heating	Upper WT-Heat	60°C/140°F[High] 35°C/95°F[Normal]
Lower limit water-out temperature at the weather-dependent mode for heating	Lower WT-Heat	55°C/131°F[High] 29°C/84°F[Normal]

② This setting will be memorized upon power failure.

3.2.2.5 Cool + Hot water

This compound mode enables the user to give priority to the “Cool” or “Hot water” mode depending on the actual demand.

[Operation Instructions]

Go to the **FUNCTION** page and locate “Cool+hot water”, then, configure it through the Up/Down key   , “Cool” or “Hot water”.

[Notes]

- ① “Hot water” will take precedence only when “Water tank” is available, other it will tell “Reserved”.
- ② This setting will be memorized upon power failure.

3.2.2.6 Heat + Hot water

This compound mode enables the user to give priority to the “Heat” or “Hot water” mode depending on the actual demand.

[Operation Instructions]

Go to the **FUNCTION** page and locate **Heat+hot water**, then, configure it through the Up/Down key   , “Heat” or “Hot water”.

[Notes]

- ① “Hot water” will take precedence only when “Water tank” is available, other it will tell “Reserved”.
- ② This setting will be memorized upon power failure.



3.2.2.7 Quiet

This function can be activated when the running noise is too high.

[Note]

when this function is activated, frequency of both the compressor and the fan will go down and the capacity of the unit will also correspondingly decrease.

[Operation Instructions]

Go to the **FUNCTION** page and locate “Quiet”, then, configure it through the Up/Down key   , “On” or “Off”.

[Notes]

- ① It can be set to “On” or “Off” no matter whether the unit is in operation or not.
- ② Once it is activated, it should be deactivated manually or by Quiet Timer.
- ③ It will not memorized and defaulted to be off upon power failure.





- ④ It will be deactivated when the unit is turned off.



3.2.2.8 Quiet Timer



When running noise is too high at some specific timer periods, this function enables the unit run quietly at this time period.



[Operation Instructions]

1. Go to the **FUNCTION** page and locate “**Quiet timer**”, then, access to the **QUIET TIMER** setting page.

2. At the **QUIET TIMER** setting page, select “**Start time**” or “**End time**” through the Left/Right keys   and then configure the desired time through the **Up/Down** keys  .

3. When the mode setting is finished, then by pressing “**Save**”, a pop-up window will pop up to remind if you are determined to save this setting. If so, press the “**OK**” key . If not, press the “**Cancel**” key  to not save this setting.

4. When the setting is saved, the control then will back to the **FUNCTION** page and the cursor will be where the “**Quiet timer**” option is, then by the **Up/Down** key  , it can be set to be “**On**” or “**Off**”.

8:30	2013/4/24	Wednesday	QUIET TIMER
Start time	End time		
08:30	17:30		
 Minute	 Save		

[Notes]

- ① Once it is activated, it should be deactivated manually.
- ② This setting will be memorized upon power failure.
- ③ The saved “**Start time**” and “**End time**” will be memorized upon power failure.
- ④ It is configurable no matter whether the unit is in operation or not.

3.2.2.9 Weather-dependent Mode

For areas with large change of diurnal temperature, in order to avoid the user to set the leaving water temperature or room temperature too often, this function will adjust automatically depending on the environmental temperature.

[Operation Instructions]

Go to the **FUNCTION** page and locate **Weatherdependent** Mode, then, configure it through the **Up/Down** key  , “**On**” or “**Off**”.

[Notes]

- ① Once it is activated, it should be deactivated manually.
- ② This setting will be memorized upon power failure.

- ③ At the “**Parameter View**” page, it is able to check the set point at the Weather dependent Mode.
- ④ When it is activated, it is allowed to set the room temperature but the set point does not take effective. However, when it is deactivated, the unit will run according to this set point.
- ⑤ It can be set to “On” or “Off” no matter if the unit is in operation or not, but be activated only when the unit is in operation.
- ⑥ This mode works only for the air conditioning function.

3.2.2.10 Holiday Release

In summer or high-temperature season, this function will make the unit pause to run in some specific periods when the user is out.

[Operation Instructions]

Go to the **FUNCTION** page and locate “**Holiday release**”, then, configure it through the Up/Down key   , “On” or “Off”.

[Notes]





- ① When it is activated, at the **WEEKLY TIMER** page, it is able to set some week day to “**Holiday release**”. In this case, the “**Weekly timer**” in this day is ineffective unless it is set to “**Effective**” manually.
- ② This setting will be memorized upon power failure.



3.2.2.11 Disinfection



This function is intended to sanitize the water tank by raising the water temperature to 70°C under which the legionella will die immediately. When this function is activated, the sanitation data and start time is configurable.

[Operation Instructions]

1. At the **FUNCTION** page, locate “**Disinfection**”, and then access to the DISINFECTION setting page by pressing the OK key  .

2. At the **DISINFECTION** setting page, select “**Set clock**”, “**Set week**” or “**Set temp**” through the Left/Right key   and then modify the corresponding setting through the Up/Down key   .

3. When the mode setting is finished, then by pressing “**Save**”, a pop-up window will pop up to remind if you are determined to save this setting. If so, press the OK key  . If not, press the Cancel key  to not save this setting.

4. When the setting is saved, the control then will back to the **FUNCTION** page and the cursor will be where the “**Disinfection**” is, then by the Up/Down key   , it can be set to “**On**” or “**Off**”.

Name	Name	Default	Range
Disinfection temperature	Set temp.	70°C	45°C~70°C

Unit Control

8:30	2013/4/24	Wednesday	DISINFECTION
Set clock	Set week	Set temp.	
08:30	Monday	70°C	
Minute	Save		



[Notes]





- ① It can be activated only when the “**Water tank**” is set to “**With**”.
- ② It can be set to “**On**” or “**Off**” no matter if the unit is in operation or not
- ③ When “**Disinfection**” is set to “**On**”, if you intend to set the “**Emergen. mode**”, “**Holiday mode**”, “**Floor Debug**”, then a window will pop up, warning “**Please disable the Disinfection Mode!**”.
- ④ It can be set to “**On**” or “**Off**” no matter if the unit is in operation or not, and “**Hot water**” mode always takes precedence.
- ⑤ When Sanitize is activated, “**Disinfection**” will show on the home page of the control until this operation is finished. If this operation fails, “**Disinfect fail**” will show. In this case, by pressing any key, “**Disinfect fail**” will be cleared or it will be always there.
- ⑥ When Sanitize is activated, it will quit upon “**Communication error with the indoor unit**” or “**Water tank heater error**”.

3.2.2.12 Weekly Timer

This function will make the unit run with certain modes in certain periods within a week based on the user's actual demand.

[Operation Instructions]

1. At the homepage, by pressing the Function key  access to the **FUNCTION** page, and then locate where “**Weekly timer**” is by switching pages, after that, press OK key  to go to the **WEEKLY TIMER** setting page.

2. At the **WEEKLY TIMER** setting page, by the Right/Left key   it is able to select the desired week day and then by the Up/Down key   to set this day, “√”, “x” or “Holiday”, as shown in the figure below. When this setting is finished, press OK key  to go to this day's setting page.

Unit Control

8:30	2013/4/24	Wednesday	WEEKLY TIMER
Monday	Tuesday	Wednesday	
X	✓	✓	
Thursday	Friday	Saturday	
Holiday	✓	✓	
	Save	Last	Next



3. At the week day's setting page, it is allowed to set the running mode (Mode), temperature set point (WT-HEAT), and water tank temperature (T-Water Tank). The running mode includes "Heat", "Cool", "Hot water", "Heat+ hot water", "Cool+ hot water" (the last three ones are available only when "Water tank" is set to "With". There are totally five periods for each day, and each period can be set to "✓" or "x". Besides, it is able to set the "Start time" and "End time" for each period, as shown in the figure below.

8:30	2013/4/24	Wednesday	MONDAY
Mode	WT-heat	T-water tank	
Heat	40°C	50°C	
Period 1	Start time	End time	
X	08:30	17:30	
		Last	Next

8:30	2013/4/24	Wednesday	MONDAY
Period 2	Start time	End time	
X	08:30	17:30	
Period 3	Start time	End time	
X	08:30	17:30	
		Last	Next

Unit Control

8:30	2013/4/24	Wednesday	MONDAY
Period 4	Start time	End time	
X	08:30	17:30	
Period 5	Start time	End time	
X	08:30	17:30	
		↑ Last	↓ Next

4. When above settings are finished, pressing the Return key and then pressing “**Save**”, a pop-up window will pop up to remind if you are determined to save these settings. If so, press the OK key . If not, press the Return key  to not save these settings.

5. In this case, finally by pressing the Up key , “**Weekly timer**” will be activated.

[Notes]

- ① Totally five periods are allowed to be set for each time. For each period, “**Start time**” must be earlier than “**End time**”. Similarly, the preceding period must be earlier than its following period.
- ② When “**Weekly timer**” has been set successfully, by changing “**FCU**”, “**Ctrl. state**”, or “**T-water ctrl.**”, then the temperature set point for “**Weekly timer**” will be automatically changed to the set point of last setting. For instance, if “**Heat**” is set for Monday of “**Weekly timer**”, “**FCU**” is set to “**With**” and the “**T-water out**” is 20°C, by resetting “**FCU**” to “**Without**”, then “**T-water out**” will be the value of last setting. In this case, if FCU is disabled for last setting, then “**T-water out**” will be the default value (18°C).
- ③ At the “**WEEKLY TIMER**” setting page there are totally three setting types for each day
 - “**√**” : it indicates once the Week Timer is activated, the timer on this day is effective and will not be affected by the “**Holiday**” mode.
 - “**×**” : it indicates even if the Week Timer is activated, the timer on this day is ineffective.
 - “**Holiday Mode**”: it indicates when the Week Timer is activated but “**Holiday Mode**” is not activated, then the timer on this day is effective; when “**Holiday**” is also activated, the timer on this day is ineffective.
- ④ When “**Weekly timer**” has already been set and the concerned modes include “**Hot water**”, if resetting “**Water tank**” from “**With**” to “**Without**”, then “**Hot water**” mode will be automatically changed to “**Heat**”, “**Cool+hot water**”/ “**Heat+hot water**” changed to “**Cool**”/ “**Heat**”.
- ⑤ **Temperature Setpoint**

The control is able to decide the temperature type and temperature range based on the current “**Clock Timer**”, “**FCU**”, “**T-water Ctrl.**”, and “**Ctrl. state**” settings. See the followings for more details.

If the set mode is “**Hot water**”, the temperature set point shows nothing, indicating there is no need to set “**T-water out**” and “**T-room**” but only “**T- tank**”. If the set mode “**Cool**” or “**Heat**”, then water tank temperature box will show nothing, indicating there is no need to set “**T-tank**”.

Ctrl. state	Set Mode	Object	Range		Default	Accuracy
T-wate	Cool	Water out temperature	7-25°C	18-25°C	7°C(With FCU)	1°C



Unit Control

Water out		for cooling(WT-cool)	(With FCU)	(Without FCU)	18°C(Without FCU)	
	Heat	Water out temperature for heating(WT-heat)	High temp.	25-60°C	45°C	1°C
			Low temp.	25-55°C	35°C	1°C
T-room	Cool	Room temperature for cooling(RT-cool)	18-30°C		24°C	1°C
	Heat	Room temperature for heating(RT-heat)	18-30°C		20°C	1°C









3.2.2.13 Clock Timer

This function will make the unit run with certain modes in certain periods within a day based on the user's actual demand.

[Operation Instructions]

- At the homepage, by pressing the **Function** key  access to the **FUNCTION** page, and then locate where **"Clock timer"** is, after that, press **OK** key  to go to the **COLCK TIMER** setting page.

8:30	2013/4/24	Wednesday	CLOCK TIMER	
Mode	WT-heat	T-water tank		
Heat	40°C	50°C		
Start time	End time			
08:30	17:30			
	 Save			

- At the **CLOCK TIMER** setting page, by the **Left/Right** key   select the desired parameter and then by the **Up/Down** key   configure it.
- When this setting is concerned about time value, by pressing the **Function** key no. 1  alternately set the hour or minute values, and by pressing the **Up/Down** key   increase or decrease the corresponding value which will be continuously changed by pressing and holding the key. (Unless otherwise specified, all timer settings follow the similar way.)
- When the setting is finished, save it by pressing the **Function** key no. 2 , or this setting without being saved is ineffective.
- When the setting has been saved, activate the **"Clock Timer"** at the **FUNCTION** page.

[Notes]



- ① IfWhen **"Weekly timer"** and **"Clock timer"** settings are performed at the same time, the latter takes precedence.
- ② When the water tank is available, the allowed running modes include **"Heat"**, **"Cool"**, **"Heat+ hot water"**, **"Cool+hot water"**, and **"Hot water"**.

- ③ When the water tank is unavailable, the allowed running modes only include “**Heat**” and “**Cool**”.
- ④ When “**Clock timer**” has already been set and the concerned modes include “**Hot water**”, if resetting “**Water tank**” from “**With**” to “**Without**”, then “**Hot water**” mode will be automatically changed to “**Heat**”, “**Cool+hot water**”/ “**Heat+hot water**” changed to “**Cool**”/ “**Heat**”.





3.2.2.14 Temp. Timer

This function will make the unit run with certain temperature in a certain period within a day based on the user’s actual demand.

[Operation Instructions]

1. At the homepage, by pressing the **Function** key  access to the **FUNCTION** page, and then locate where “**Temp. timer**” is, after that, press **OK** key  to go to the **TEMP TIMER** setting page.

8:30	2013/4/24	Wednesday	TEMP TIMER
Mode	Period 1	WT-heat 1	
Heat	08:30	40°C	
Period 2	WT-heat 2		
08:30	40°C		
	 Save		

2. At the TEMP TIMER setting page, by the **Left/Right** key   select the desired parameter and then by the **Up/Down** key   configure it. The configurable parameters include “**Mode**”, “**Period 1**”, “**WT-HEAT 1**”, “**Period 2**” and “**WT-HEAT 2**”.
3. When the setting is finished, save it by pressing the **Function** key no. 2 , or this setting without being saved is ineffective.
4. When the setting has been saved, activate the “**Temp. timer**” at the **FUNCTION** page.

[Notes]

- ① When “**Weekly timer**”, “**Clock timer**”, and “**Temp. timer**” settings are performed at the same time, the last one takes precedence.
- ② This function works only when the unit is in operation.
- ③ The allowed running modes include “**Heat**” and “**Cool**”
- ④ When the start time of “**Period 2**” is equal to that of “**Period 1**”, then the set point of “**Period 2**” takes precedence.
- ⑤ TEMP. TIMER is judged by the timer value.
- ⑥ During the setting, the temperature set point which is set manually always takes precedence.



3. 2.2.15 Solar kit



This mode can be set to On/Off/Timer. If **On Mode** is chosen, the solar system will be activated while the temperature required is satisfied; if Off Mode is chosen, the solar system will not be activated; if Timer

Unit Control



Mode is chosen, the solar system will be activated in the setting time while the temperature required is satisfied.

[Operation Instructions]





1. Go to the **FUNCTION** page and locate “**timer**”, then press UP/DOWN keys   to chose On/Off/Timer mode.

8:30	2013/4/24	Wednesday	FUNCTION
Clock timer	Temp. timer	Solar kit	
Off	Off	Off	
Floor debug	Emergen. mode	Holiday mode	
Off	Off	Off	
 Enter		 Last	 Next



2. When Timer mode is chosen, press on leftdown or enter key to enter the Timer setting page as shown below.

8:30	2013/4/24	Wednesday	SOLAR TIMER
Sart time	End time		
08:30	17:30		
 Minute	 Save		

No.	Full Name	Displayed Name	Range	Default
1	Solar kit start time	Start time	0:00~24:00	8:00
2	Solar kit stop time	Stop time	0:00~24:00	18:00

3. At the “**Solar Timer**” page, locate “**Start time**” or “**End time**” through the up and down keys   and then adjust the start or stop time also through the up and down keys  .

4. After configuration, press “Save” and then a dialog box will pop up. In the dialog box, press “OK” to confirm the configuration, or press “Cancel”  to cancel this configuration.

5. After saving the configuration, this page will automatically back to the **FUNCTION** page with the cursor stayed at “**Solar timer**”, and then through the up and down keys   to set it to be “ON” to activate “**Solar timer**”.

[Notes]



Unit Control

- ① Once “**Solar timer**” is activated, it cannot be deactivated through ON/OFF operation but be done manually.
- ② “**Start time**” and “**End time**” will be memorized upon power failure
- ③ It can be set under both ON and OFF states





3. 2.2.16 Floor Debug

This function will make the unit to perform periodic preheating to the floor for the initial run once floor coils have been installed.





[Operation Instructions]

1. At the homepage, by pressing the **Function** key  access to the **FUNCTION** page, and then locate where “**Floor debug**” is, after that, press **OK** key  to go to the **FLOOR DEBUG** setting page.



8:30	2013/4/24	Wednesday	FLOOR DEBUG
Segments	Period 1 temp	Δ T of segment	
1	25°C	5°C	
Segment time			
0 H			
	 Start		

2. At the **FLOOR DEBUG** setting page, by the **Left/Right** key   select the desired parameter and then by the **Up/Down** key   configure it. The configurable parameters include “**Segments**”, “**Period 1 temp**”, “**ΔT of segment**”, and “**Segment time**”, as listed in the following table.

No.	Full Name	Displayed Name	Range	Default	Accuracy
1	Segments for floor debug	Segments	1~10	1	1
2	First temperature for floor debug	Period 1 temp	25~35°C/77~95°F	25°C/77°F	1°C/1°F
3	Segment temperature difference for floor debug	ΔT of segment	2~10°C/36~50°F	5°C/41°F	1°C/1°F
4	Segments duration for floor debug	Segment time	0~72H	0	12H

3. After the above setting is finished, by pressing the function key no.2  activate this function and a dialog box will pop up, reminding “**Start the Floor Debug Mode now?**”. If so, press the “**OK**” key  . Once “**Floor debug**” has been activated, by pressing the **function** key no.2  , a dialog box also will pop up, reminding “**Stop the Floor Debug Mode now?**” If so, press the **OK** key  ; if not, press “**Cancel**”  to go on.

[Notes]

- ① This function can be activated only when the unit is **OFF**. When it is intended to activate this function with the unit being **ON**, a dialog box will pop up, warning “**Please turn off the system first!**”.
- ② When this function has been activated, it is unable to turn on or off the unit. In this case, when pressing the **ON/OFF** key , a dialog will pop up, warning “**Please disable the Floor Debug Mode!**”.
- ③ When this function has been set successfully, “**Timer week**”, “**Clock timer**” and “**Temp timer**” will be deactivated.
- ④ ” When “Floor debug” mode has been activated, Both “**Emergen.mode**” and “**Holiday mode**” are not allowed to be activated, or a dialog box will pop up, warning “**Please disable the Floor Debug Mode!**”.
- ⑤ Upon power failure, this function will be **OFF** and runtime will be cleared.
- ⑥ At the **FLOOR DEBUG** setting page, the control will remain at this page and never back to the homepage unless pressing the **Return** key  or **Menu** key .
- ⑦ When this function is activated, it is allowed to check the target temperature and runtime of “**Floor Debug**” at the Parameter View page.
- ⑧ Before activating “**Floor debug**”, please make sure each period for “**Floor debug**” is not zero, or a dialog box will pop up, warning “**Wrong Floor Debug time!**”. It will resume only by pressing “**OK**” and then correcting the time.

3.2.2.17 Emergency Mode (Emergen. Mode)

When the compressor fails to run owing to some urgent conditions, this function will allow the unit to run in the “**Heat**” mode through the assistant heater.

[Operation Instructions]

1. Set “**Mode**” to “**Heat**” at the Parameter Set page.

2. Then, switch pages to go the page where “**Emergen. mode**”, locate it by the **Left/Right** key 

, and configure it to “**On**” or “**Off**” by the **Up/Down** key  .

3. When it is set to “**On**”, “**Auxiliary func.**” at the homepage will be replaced by “**Emergen. Mode**”.

4. When it is set to “**On**” but the running mode is not “**Heat**”, a dialog will pop up, warning “**Wrong**

running mode!”. In this case, by pressing the **OK** key , the control will go to the Mode setting

page, or by pressing the **Cancel** key , the control will return to the “**Emergen. Mode**” page.

[Notes]

- ① When the unit is performing “**Heat**” at the Emergency mode, if there is water flow switch protection, IDU assistant heater welding protection, or leaving water temperature sensor error, the Emergency mode will quit and will not be allowed to be activated.
- ② When the unit is performing “**Hot water**” at the Emergency mode, if there is water tank heater welding protection, or water tank temperature sensor error, the Emergency mode will quit and will not be allowed to be activated.
- ③ At the Emergency mode, the **ON/OFF** key  operation will be disabled; the running mode



will not be allowed to be changed; the Quiet Mode and Weather-dependent Mode cannot be deactivated; **“Weekly timer”**, **“Clock timer”** and **“Temp timer”** also cannot be activated, or will be deactivated if being activated.

- ④ At the Emergency mode, commands from the Thermostat is ineffective.
- ⑤ At the Emergency mode, only one running mode between **“Heat”** and **“Hot water”** is allowed.
- ⑥ This function can be activated only when the unit is **OFF**, or a dialog box will pop up, warning **“Please turn off the system first!”**
- ⑦ Under the Emergency mode, **“Floor debug”**, **“Sanitize”**, **“Holiday mode”**, cannot be activated, or a dialog box will pop up, warning **“Please disable the Emergency Mode!”**.
- ⑧ Upon power failure, the **“Emergen. mode”** will be defaulted to be **“Off”**.

3.2.2.18 Holiday Mode

In winter or low-temperature season, this function will control the leaving water temperature or room temperature within a certain range to avoid the water system from being frozen when the user is out on holiday for a long time.

[Operation Instructions]

1. Locate where **“Holiday mode”** at the **Parameter Set** page.
2. Set Holiday to **“On”** or **“Off”** by the **Up/Down** key   .



[Notes]

- ① At the holiday mode, the unit will automatically go to the **“Heat”** mode and **“Mode”** setting of the control and **“On/Off”** key operation both are disabled.
- ② When it is activated, **“Weekly timer”**, **“Clock timer”** or **“Temp. timer”** will be deactivated.
- ③ At the holiday mode, when **“T-Room”** is adopted, the temperature set point should be 10□; when **“T-Out water”** is adopted, then the temperature set point should be 30°C.
- ④ It will quit when the thermostat effectively works (**“Cool”** or **“OFF”** operation).
- ⑤ When this setting is saved successfully, it will be memorized upon power failure.
- ⑥ This function can be activated only when the unit is **OFF**, or a dialog box will pop up, warning **“Please turn off the system first !”**.
- ⑦ When it is activated, the **ON/OFF** key  operation is disabled, or a dialog box will pop up, warning **“Please disable the Holiday Mode !”**.
- ⑧ Under the Holiday mode, **“Floor debug”** and **“Emergen. mode”** cannot be activated, or a dialog box will pop up, warning **“Please disable the Holiday Mode !”**.

2.2.19 Thermostat

When the thermostat has been installed, it can be used to control the run mode of the unit (only **“Heat”** or **“Cool”** mode)

[Operation Instructions]

1. Locate where **“Thermostat”** is at the **FUNCTION** page.
2. By pressing the **Up/Down** key   , Thermostat can be set to **“On”** or **“Off”**. When it is

“On”, the control follows the running mode of the thermostat and is not allowed to set the running mode; when it is **“Off”**, the control follows the running mode set by itself.

[Notes]

- ① When the water tank is unavailable, the **“Air+hot water”** mode also is unavailable.
- ② When **“Floor debug”** or **“Emergen. Mode”** is activated, then the control will not receive signals from the thermostat.

- ③ If “**Thermostat**” is set to “**On**”, the control will automatically disable some functions concerning timer, and run in accordance with the mode set by the thermostat. In this case, the running mode is unchangeable and the **ON/OFF** key  operation of the control is ineffective.
- ④ When this setting is saved successfully, it will be memorized upon power failure.
- ⑤ Under the “**Air+hot water**” mode, the unit can perform water heating even though the thermostat is set to “**Off**”.
- ⑥ The state of the Thermostat can be changed when the unit is turned off.

3.2.2.20 Assistant Heater(Assis. Heater)

There are three options for the assistant heater, “ 1 group”, “2 groups” or “Without”.

[Operation Instructions]

Go to the **FUNCTION** page and locate “**Assistant heater**”, then, configure it through the Up/Down key  , “**With**” or “**Without**”.

[Notes]

It will be memorized upon power failure.

3.2.2.21 Other Heater

It can be configured to “**With**” or “**Without**” through the wired controller.

[Operation Instructions]

Go to the **FUNCTION** page and locate **Other heater**, then, configure it through the **Up/Down** key  , “**With**” or “**Without**”.

[Notes]

It will be memorized upon power failure.

3.2.2.22 Chassis Heater

The user will decide if to activate or deactivate the chassis heater. Generally it is suggested to activate it under low environment temperature, “**Heat**” mode or “**Hot water**” mode to prevent the chassis from being frozen.

[Operation Instructions]

Go to the **FUNCTION** page and locate “**Chassis Heater**” then, configure it through the **Up/Down** key  , “**On**” or “**Off**”.

[Notes]

It will be memorized upon power failure.

2.2.2.23 Tank heater

When the water tank is installed, it will be activated automatically and cannot be changed.

2.2.2.24 Plate heater

The plate heater can be activated or deactivated by the user. Generally it is suggested to activate it when the water pump has stopped and the environment temperature is lower than 2°C so as to prevent the heat exchanger from being frozen.

[Operation Instructions]

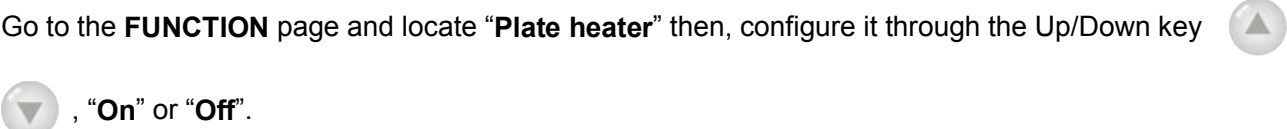
Go to the **FUNCTION** page and locate “**Plate heater**” then, configure it through the Up/Down key  , “**On**” or “**Off**”.

[Notes]

It will be memorized upon power failure.

3.2.2.25 Solar antifre

When the solar system has been installed, it is highly suggested to activate this function.

[Operation Instructions]

Go to the **FUNCTION** page and locate “**Solar antifre**” then, configure it through the Up/Down key

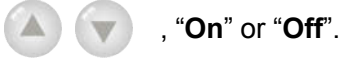

[Notes]

It will be memorized upon power failure.

3.2.2.26 Water Tank

It can be configured to be “**With**” or “**Without**” based on the actual condition.

[Operation Instructions]

Go to the **FUNCTION** page and locate “**Water tank**” then, configure it through the Up/Down key



[Notes]

- ① It will be memorized upon power failure.
- ② This setting is allowed only when the unit is turned off.

3.2.2.27 Tank Sensor

When the water tank has been installed, one group or two groups of tank sensors can be selected to detect and control the water tank temperature.

[Operation Instructions]

Go to the **FUNCTION** page and locate “**Water tank**”, then, configure it through the Up/Down key

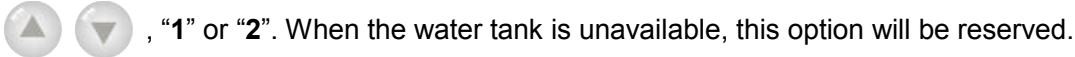

[Notes]

It will be memorized upon power failure.

2.2.28 Solar Heater

It can be configured to be “**With**” or “**Without**” based on the actual condition.

[Operation Instructions]

Go to the **FUNCTION** page and locate “**Solar heater**”, then, configure it through the Up/Down key



[Notes]

It will be memorized upon power failure.

3.2.2.29 Floor config

It can be configured to be “With” or “Without” based on the actual condition.

[Operation Instructions]

Go to the **FUNCTION** page and locate “**Floor config**”, then, configure it through the Up/Down

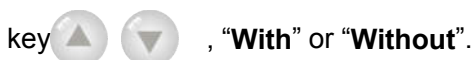

[Notes]

- ① It will be memorized upon power failure.
- ② When it is set to be “With”, the water temperature will be set to “Normal temp.” automaticy.

- ③ When it is set to be “Without”, the water temperature will be set to “High temp.” automaticy.
- ④ “Floor config” can be changed only when the unit is turned off.

2.2.30 Radia config

It can be configured to be “**With**” or “**Without**” based on the actual condition.

[Operation Instructions]

Go to the **FUNCTION** page and locate “Radia config”, then, configure it through the **Up/Down** key

  , “**With**” or “**Without**”.

[Notes]

- ① It will be memorized upon power failure.
- ② When it is set to “**with**”, the water temperature is defaulted to be “**High temp.**”

3.2.2.31 FCU

It can be configured to be “**With**” or “**Without**” based on the actual condition.

[Operation Instructions]

Go to the **FUNCTION** page and locate “**FCU**”, then, configure it through the **Up/Down** key 

 , “**With**” or “**Without**”.

[Notes]



It will be memorized upon power failure.

2.2.32 Remote Sensor

It can be configured to be “**With**” or “**Without**” based on the actual condition.

[Operation Instructions]

Go to the **FUNCTION** page and locate “**Remote sensor**”, then, configure it through the **Up/Down**

key   , “**With**” or “**Without**”.

[Notes]



- ① It will be memorized upon power failure.
- ② “**T-room ctrl**” can be selected only when the Remote Sensor is set to “**With**”.

3.2.2.33 Air removal

This function is intended to expel air inside the water system with only the water pump in operation when installation of the unit is finished.

[Operation Instructions]

Go to the **FUNCTION** page and locate “**Air removal**”, then, configure it through the **Up/Down** key

  , “**On**” or “**Off**”.

[Notes]



- ① It will not be memorized upon power failure.
- ② It can be set only when the unit is turned off.

3.2.2.34 Address

It is used to identify the unit in use in the central control system.

[Operation Instructions]

Go to the **FUNCTION** page and locate “**Address**”, then, configure it through the **Up/Down** key

  to set the address.

[Notes]



- ① It indicates the address of the control and is intended for the group control.
- ② It will not be memorized upon power failure.
- ③ The address range is [1,125] and [127,253]
- ④ The default address is 1 for the initial use.

3.2.2.35 Gate-Controller (Gate-Ctrl.)

It can be configured to be “On” or “Off” based on the actual condition.

[Operation Instructions]

Go to the **FUNCTION** page and locate “**Gate-Controller**”, then, configure it through the Up/Down

  key , “On” or “Off”.

[Notes]

- ① When it is activated, the control will check the card is inserted or not. If inserted, the control will run normally; if not, the control will turn off the unit and back to the homepage. In this case, any key operation is ineffective (except for the combined key operation), or a dialogue box will pop up, warning “**Keycard uninserted!**”.
- ② It will not be memorized upon power failure.



3.2.3 Parameter Setting (Parameter Set)**3.2.3.1 User Parameter Setting**

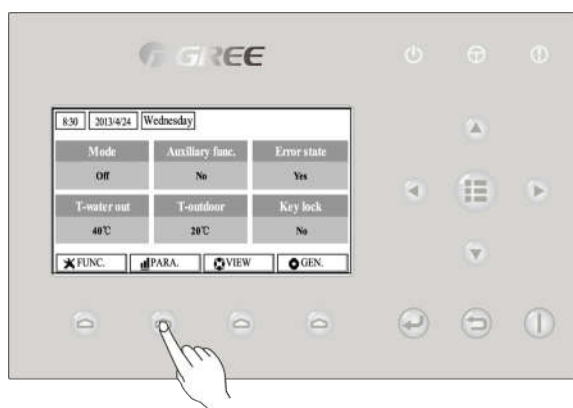

At the parameter setting pages, each parameter is configurable, like: water out temperature for cooling, water out temperature for heating, and water tank temperature etc.



**[Operation Instructions]**

1. At the homepage, it is able to go to the **PARAMETER** page by pressing the Function key no. 2



2. At the **Parameter Set** page, by the Left/Right key   select the desired option and then

by the Up/Down key   increase or decrease the setting value which will be continuously changed when pressing and holding the key.

3. When the setting is finished, press “**Save**”  and a dialog box will pop up, reminding “**Save settings?**”. If so, press the OK key  ; if not press the Cancel key  to not save this setting.

[Notes]

- ① For those parameter which default value vary by different condition, the value will set to default

Unit Control

when the condition changes.

8:30	2013/4/24	Wednesday	PARAMETER
WOT-Cool	WOT-heat	RT-Cool	
18°C	40°C	20°C	
RT-Heat	T-water tank	T-Eheater	
26°C	50°C	0°C	
Save	Last	Next	

User Setting

No	Full Name	Displayed Name	Range		Default
1	Water out temperature for cooling	WOT-Cool	7~25°C [With FCU] 18~25°C [Without FCU]	45~77°F [With FCU] 64~77°F [Without FCU]	7°C/45°F[With FCU] 18°C/64°F[Without FCU]
2	Water out temperature for heating	WOT-Heat	25~60°C[High temp.] 25~55°C[Normal temp.]	77~140°F[High temp.] 77~131°F[Normal temp.]	45°C/113°F[High temp.] 35°C/95°F[Normal.]
3	Room temperature for cooling	RT-Cool	18~30°C	64~86°F	24°C/75°F
4	Room temperature for heating	RT-Heat	18~30°C	64~86°F	20°C/68°F
5	Tank temperature	T-water tank	40~80°C	104~176°F	50°C/122°F
6	Eheater-on ambient temperature	T-Eheater	-22~18°C	-8~64°F	-7°C/19°F
7	Extra-heater-on ambient temperature	T-Extraheater	-22~18°C	-8~64°F	-15°C/5°F
8	Max heat pump waterout temperature (no eheater)	T-HP Max	40~50°C	104~122°F	50°C/122°F
9	Solar kit-max water temp	Solarwater Max	50~80°C	122~176°F	80°C/176°F
10	Lower limit ambient temperature at the Weather-dependent Mode for heating	Lower AT-Heat	-22~5°C	-8~41°F	-20°C/-4°F
11	Upper limit temperature at the Weather-dependent Mode for heating	Upper AT-Heat	10~37°C	50~99°F	25°C/77°F

Unit Control

12	Upper limit room temperature at the Weather-dependent Mode for heating	Upper RT-Heat	22~30°C	72~86°F	24°C/75°F Set to default value when the Weather-dependent Mode setting changes.
13	Lower limit room temperature at the Weather-dependent Mode for heating	Lower RT-Heat	18~21°C	64~70°F	18°C/68°F Set to default value when the Weather-dependent Mode setting changes.
14	Upper limit water-out temperature at the Weather-dependent Mode for heating	Upper WT-Heat	56~60°C[High temp.] 30~55°C[Normal temp.]	133~140°F[High temp.] 86~95°F [Normal temp.]	60°C/140°F[High temp.] 35°C/95°F[Low temp.] Set to default value when the Weather-dependent Mode setting changes.
15	Lower limit water-out temperature at the Weather-dependent Mode for heating	Lower WT-Heat	55~58°C[High temp.] 25~29°C[Normal temp.]	131~136°F[High temp.] 77~84°F [Normal temp.]	50°C/131°F[High temp.] 29°C/84°F[Low temp.] Set to default value when the Weather-dependent Mode setting changes.
16	Lower limit ambient temperature at the Weather-dependent Mode for cooling	Lower AT-Cool	8~25°C	46~77°F	25°C/77°F
17	Upper limit temperature at the Weather-dependent Mode for cooling	Upper AT-Cool	26~50°C	79~122°F	40°C/104°F
18	Upper limit room temperature at the Weather-dependent Mode for cooling	Upper RT-Cool	24~30°C	75~86°F	27°C/81°F
19	Lower limit room temperature at the Weather-dependent Mode for cooling	Lower RT-Cool	18~23°C	64~73°F	22°C/72°F
20	Upper limit water-out temperature at the Weather-dependent Mode for cooling	Upper WT-Cool	15~25°C[With FCU] 22~25°C[Without FCU]	59~77°F [With FCU] 72~77°F [Without FCU]	15°C/59°F[With FCU] 23°C/73°F[Without FCU]
21	Lower limit water-out temperature at the weather-dependent mode for cooling	Lower WT-Cool	7~14°C[With FCU] 18~21°C[Without FCU]	45~57°F[With FCU] 64~70°F[Without FCU]	7°C/45°F[With FCU] 18°C/64°F[Without FCU]
22	Temperature deviation for cooling	ΔT-Cool	2~10°C	36~50°F	5°C/41°F

Unit Control

23	Temperature deviation for heating	ΔT -Heat	2~10°C	36~50°F	10°C/50°F
24	Temperature deviation for heating water	ΔT -hot water	2~8°C	36~46°F	5°C/41°F
25	Room temp variation	ΔT -Room temp	1~5°C	36~41°F	2°C/36°F
26	Run time	Run time	1~10min	3min[with FCU or Radiator]	
				5min[witnout FCU and Radiator]	
27	Solar kit-start temp variation	T-Solar start	10~30°C	50~86°F	15°C/59°F
28	Solar pannel-max. temp	SL- pannel Max	90~130°C	194~266°F	110°C/230°F

3. 2.4 View

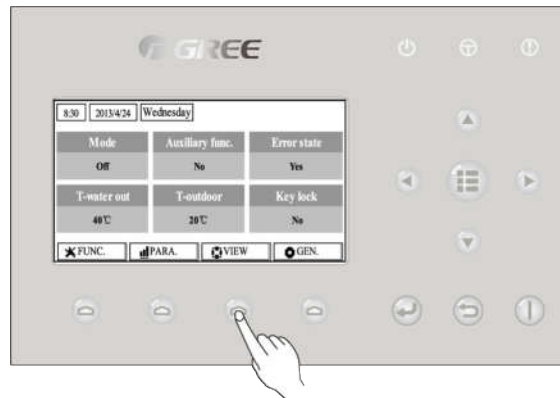

At the view pages, the user is enabled to view the unit's running state, running parameters, errors, version of the wired controller etc.

[Operation Instructions]

At the homepage, by pressing the Function key no.3  , it is able to go to the **VIEW** page as shown in the figure below.

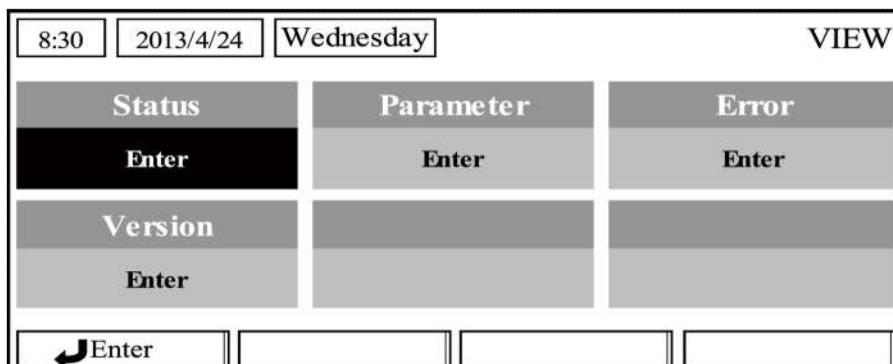

3. 2.4.1 Status View

At the status view pages, the user is enabled to view the unit's running status, like compressor On/Off, fan 1 On/Off, water pump On/Off, antifreeze On/Off, defrost On/Off etc.

[Operation Instructions]

Unit Control

1. At the **VIEW** page, select “**Status**” and then press the OK key  to go to the **STATUS** page.
2. At the **STATUS** page, it is able to check the status of each component.

8:30	2013/4/24	Wednesday	STATUS
Compressor	Fan 1	Fan 2	
Off	Off	Off	
IDU-WP	Solar-WP	Tank heater	
Off	Off	Off	
		↑ Last	↓ Next

Viewable Components

Full Name	Displayed Name	Status
Compressor running state	Compressor	On/Off
Fan 1 running state	Fan 1	On/Off
Fan 2 running state	Fan 2	On/Off
Heat pump-water pump	HP-pump	On/Off
Solar water pump running state	SL-pump	On/Off
Swimming pool-water pump	Swimming-pump	On/Off
Tank heater running state	Tank heater	On/Off
3-Way valve 1 running state	3-way valve 1	On/Off
3-Way valve 2 running state	3-way valve 2	On/Off
Crankcase heater running state	Crankc.heater	On/Off
Chassis heater running state	Chassis heater	On/Off
Plate heat exchanger heater	Plate heater	On/Off
Defrost	Defrost	On/Off
Oil return	Oil return	On/Off
Thermostat	Thermostat	Off/Cool/Heat
Assistant heater running state	Assist. Heater	On/Off
Circulating two-way valve 1 running state	2-way valve 1	On/Off
Circulating two-way valve 2 running state	2-way valve 2	On/Off
Doorguard	Doorguard	Card in/Card out
Opration LED	Opration LED	On/Off
Error LED	Error LED	On/Off
4-way valve running state	4-way valve	On/Off
Enthalpy-enhancing solenoid valve	En.valve	On/Off
Heat pump-auxiliary heater 1	HP-heater 1	On/Off
Heat pump-auxiliary heater 2	HP-heater 2	On/Off
Solar kit- freeze protection	SL-Antifree	Enabled/Disabled
Heat pump-freeze protection	HP-Antifree	Enabled/Disabled

3. 2.4.2 Parameter View (Para View)

At the parameter view pages, the unit is enabled to view the units' running parameters, like outdoor

Unit Control

temperature, suction temperature, discharge temperature, water in temperature, water out temperature etc.

[Operation Instructions]

1. At the **VIEW** page, select **Parameter** and then press the OK key  to go to the **Para View** page.
2. At the **Para View** page, it is able to view each parameter.

8:30	2013/4/24	Wednesday	PARAMETER
T-outdoor	T-suction	T-discharge	
26°C	26°C	26°C	
T-defrost	T-liquid	T-water in	
26°C	26°C	26°C	
		↑ Last	↓ Next

No.	Full Name	Displayed Name
1	Outdoor temperature	T-outdoor
2	Suction temperature	T-suction
3	Discharge temperature	T-discharge
4	Defrost temperature	T-defrost
5	Plate heat exchanger Water in temperature	T-water in PE
6	Plate heat exchanger water-out temperature	T-waterout PE
7	E-heater water-out temperature	T-waterout EH
8	Water tank temperature set point	T-tank ctrl.
9	Water tank temperature reading	T-tank display
10	Remote room temperature	T-remote room
11	Solor kit-entering water temp	T-SL water I
12	Solor kit-leaving water temp	T-SL water O
13	Solar panel temp	T-SL panel
14	Swimming pool-water temp	T-Swimming
15	Swimming pool-entering water temp	T-Swimming in
16	Swimming pool-leaving water temp	T-Swimming out
17	Discharge pressure	Dis.pressure
18	Enthalpy-enhancing pressure	En.pressure
19	Suction pressure	Su.pressure
20	Target temperature for Weather-dependent Mode	T-auto mode
21	Target temperature for floor debug	T-floor debug
22	Time period for floor debug	Debug time

3. 2.4.3 Error View

Unit Control



At the error view pages, the user is enabled to see which error the unit suffers.

[Operation Instructions]

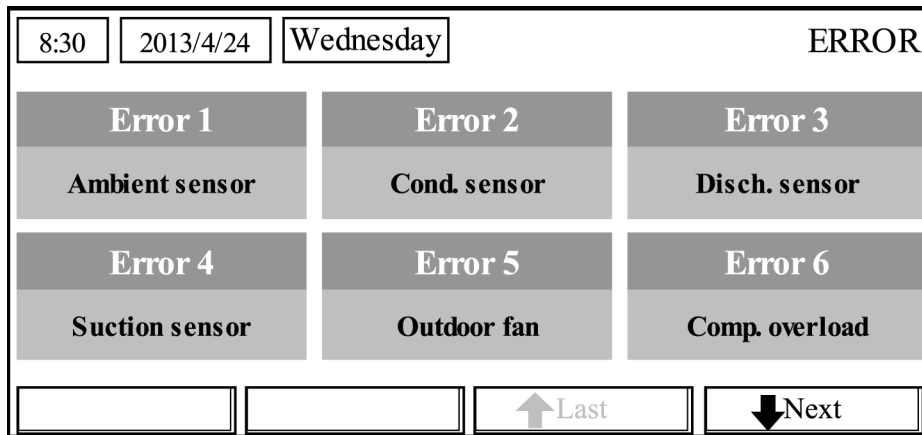
1. At the **VIEW** page, select **Error** and then press the OK key to go to the **ERROR** page.
2. At the **Error View** page, it is able to view each error.



[Notes]

- ① The real-time error will show on the control. Taking Error 2 in the above figure for example, when it is recovered, it will disappear and be replaced by Error 3, and other errors follow the same way.
- ② If the total no. of errors exceed six, other errors should be viewed by switching pages through “Last”  and “Next” .
- ③ Any one among “IDU auxiliary heater 1 error”, “IDU auxiliary heater 2 error”, “Water tank heater error” occurs, the control will beep until this error has been cleared.

See the following table for error description.

No.	Full Name	Displayed Name	Error Code
1	Ambient temperature sensor error	Ambient sensor	F4
2	Defrost temperature sensor error	Defro. sensor	d6
3	Discharge temperature sensor error	Disch. sensor	F7
4	Suction temperature sensor error	Suction sensor	F5
5	Outdoor fan error	Outdoor fan	EF
6	Compressor internal overload protection	Comp. overload	H3
7	High pressure protection	High pressure	E1
8	Low pressure protection	Low pressure	E3
9	High discharge protection	Hi-discharge	E4
10	Refrigerant loss protection	Refri-loss	P2
11	Heat pump-water pump protection	HP-pump	E0
12	Solar kit-water pump protection	SL-pump	EL
13	Swimming pool-water pump protection	Swimming-pump	
14	Incorrect capacity DIP switch setting	Capacity DIP	c5
15	Communication error between indoor and outdoor unit	ODU-IDU Com.	E6
16	Drive communication error	Drive com.	
17	High pressure sensor error	HI-pre. sens.	Fc
18	Enthalpy-enhancing sensor error	En. senser	F8
19	Low pressure sensor error	LOW-pre. Sens.	dL

Unit Control

20	Heat exchanger-leaving water temperature sensor error	Temp-HELW	F9
21	Auxiliary heater-leaving water temperature sensor error	Temp-AHLW	dH
22	Heat exchanger-entering water temperature sensor error	Temp-HEEW	
23	Water tank water temperature sensor 1 error	Tank sens. 1	FE
24	Water tank water temperature sensor 2 error	Tank sens. 2	
25	Solar kit-entering water temp sensor	T-SL water out	
26	Solar kit-leaving water temp sensor	T-SL water in	FH
27	Solar kit- temp sensor	T-Solar pannel	FF
28	Swimming pool-entering water temp sensor	T-Swimming in	
29	Swimming pool-leaving water temp sensor	T-Swimming out	
30	Swimming pool-water temp sensor	T-Swimming	
31	Remote room sensor 1	T-Remote Air1	F3
32	Remote room sensor 2	T-Remote Air2	
33	Heat pump-water flow switch	HP-Water SW	Ec
34	Solar kit-water flow switch	SL-Water SW	F2
35	Swimming pool-water flow switch	SW-Water SW	F1
36	Welding protection of the auxiliary heater 1	Auxi. heater 1	EH
37	Welding protection of the auxiliary heater 2	Auxi. heater 2	EH
38	Welding protection of the water tank heater	Auxi. -WTH	EH
39	Under-voltage DC bus or voltage drop error	DC under-vol.	PL
40	Over-voltage DC bus	DC over-vol.	PH
41	AC current protection (input side)	AC curr. pro.	PA
42	IPM defective	IPM defective	H5
43	PFC defective	FPC defective	Hc
44	Start failure	Start failure	Lc
45	Phase loss	Phase loss	LD
46	Drive module resetting	Driver reset	P6
47	Compressor over-current	Com. over-cur.	P0
48	Overspeed	Overspeed	P5
49	Sensing circuit error or current sensor error	Current sen.	LF
50	Desynchronizing	Desynchronize	Pc
51	Compressor stalling	Comp. stalling	H7
52	Communication error	drive-main com.	LE
53	Radiator or IPM or PFC module overtemperature	Overtemp.-mod.	P8
54	Radiator or IPM or PFC module temperature sensor error	T-mod. sensor	P7
55	Charging circuit error	Charge circuit	Pu
56	Incorrect AC voltage input	AC voltage	PP
57	Drive board temperature sensor error	Temp-driver	PF
58	AC contactor protection or input zero crossing error	AC contactor	P9
59	Temperature drift protection	Temp. drift	PE
60	Current sensor connection protection (current sensor not connected to phase U/V)	Sensor con.	PD
61	Communication error to the outdoor unit	ODU Com.	E6
62	Communication error to the indoor unit	IDU Com.	E6

Unit Control

63	Communication error to the drive	Driver Com.	E6
64	Solar kit-superheating	Solarsuperheat	F6

3. 2.4.4 Version View (VERSION)

At the version view **page**, the user is enabled to see the version of the program and the protocol.

[Operation Instructions]

1. At the **VIEW** page, select **Version** and then press the OK key  to go to the **VERSION** page.
2. At the **VERSION** page, the program and protocol versions are listed.

8:30	2013/4/24	Wednesday	VERSION
Program	Protocol		
V 10	V 10		

3. 2.5 General Setting

At the general setting pages, the user is enabled to configure general parameters, like temperature unit, language, On/off memory, time & date etc.

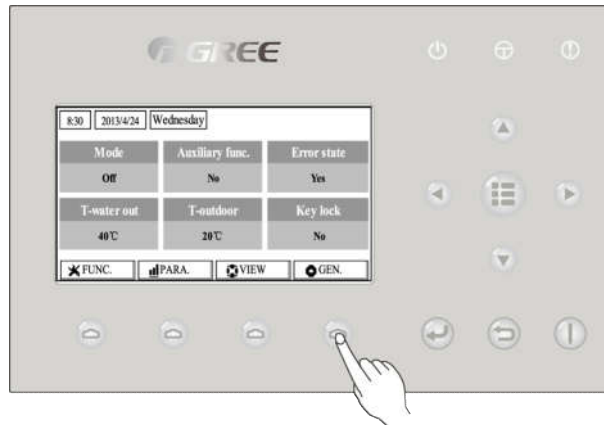

[Operation Instructions]

At the homepage, by pressing “**GEN.**”  access to the GENERAL SET page. At this page, it is able to set “**Temp. unit**”, “**Language**”, “**On/off memory**”, “**Time & Date**”, “**Beeper**” and “**Back light**”, as shown in the figure below.



Unit Control





8:30	2013/4/24	Wednesday	GENERAL SET
Temp. unit	Language	On/off memory	
Celsius	English	On	
Time&Date	Beeper	Back light	
Enter	Off	Lighted	

No.	Full Name	Displayed Name	Range	Default	Remarks
1	Temperature unit	Temp. unit	Celsius/Fahrenheit	Celsius	/
2	Language	Language	中文/English	English	/
3	On/off memory	On/off memory	On/Off	On	/
4	Time&Date	Time&Date	/	/	/
5	Beeper	Beeper	On/Off	On	/
6	Back light	Back light	Lighted/Energy save	Energy save	“On”: it always lights on. “Eco”: it lights off when there is no key operation for 1 minute, and will lights on where there is any key operation.

3. 2.5.1 Time&Date

[Operation Instructions]

At the homepage, by pressing “GEN.”  access to the **GENERAL SET** page. Then, select “Time & Date” at this page. After that, go to the “Time & Date” setting page by pressing the OK key .

Change the set value by pressing the Up/Down key  . Then by pressing “Save”, a pop-up window will pop up to remind if you are determined to save this setting. If so, press the OK key . If not, press the Cancel key  to not save this setting. The saving setting will update at the upper left corner of the control.



Unit Control





8:30	2013/4/24	Wednesday	Time&Date
Year	Mounth	Day	
2013	4	25	
Hour	Minute		
16	35		
	 Save		

3. 2.6 Key Lock

This function can be activated or deactivated through the wired controller. Once it is activated, any key operation will become ineffective.

[Operation Instructions]

At the homepage, by pressing the up and down keys   simultaneously for 5 seconds, it is able to activate or deactivate this function. When it is activated, any key operation is ineffective and the key lock icon in main page and standby page will display Yes.

8:30	2013/4/24	Wednesday	
Mode	Auxiliary func.	Error state	
Off	No	Yes	
T-water out	T-outdoor	Key lock	
40°C	20°C	Yes	
 FUNC.	 PARA.	 VIEW	 GEN.

UNIT INSTALLATION

1. Installation Guides

WARNING!

- Installation should be performed by GREE appointed servicemen, or improper installation would lead to unusual operation, water leakage, electric shock or fire hazard.
- The unit should be installed on the foundation which is capable of supporting the unit, or the unit would fall off or even lead to personal injury.
- All electric installation should be done by electrician in accordance with local laws and regulations, as well as the User's Manual and this Service Manual. Besides, the special power lines should be used, as any improper line would lead to electric shock or fire hazard.
- All electric lines should be safe and secured reliably. Be sure the terminal board and electric lines will not be affected by any external force, or it would lead to fire hazard.
- The electric lines should run properly to make the cover of the electric box secured tightly, or it would cause the terminal board overheated or cause electric shock or fire hazard.
- Cut off the power supply before touching any electric element.

CAUTION!

- The unit should be grounded properly and the ground line is not allowed to connect with the gas line, water line, lightning rod or phone line.
- The breaker should be installed, or it would lead to electric shock.
- The drain pipe should be installed in accordance with the User's Manual and this Service Manual to ensure free drainage, and the drain pipe should be insulated against condensation. Once the drain pipe is installed improperly, it would lead to water leak which then will damp the ceiling and furniture.
- Do not place the unit where there is oil fog, like kitchen, or the plastic would be aged, broken off or the polluted evaporator would lead to water leak and poor performance.
- Do not place the unit where there is corrosive gas (like sulfur dioxide), or the corroded copper tubes or welded joint would lead to refrigerant leakage.
- Do not place the unit where there is inflammable gas, carbon fiber, inflammable dust or volatile combustible, as they would lead to fire hazard.

SAFETY!

- Always use safety outfits at the construction site.
- No smoking and no drunken operation are allowed at the construction site.
- Wear no gloves and tighten the cuff when operating the machinery and electrical equipment. Do not maintain it during operation.
- Use the abrasive-disk cutter and stand at the side of the rotating abrasive disk.
- Clean the opening when installing the riser pipe, and then cover it tightly. Do not throw down any material.
- The use of the electric and gas welders should be approved firstly. Once used, a fire extinguisher should be prepared and a service man should be there always. There should be no inflammable and explosive substances around the welding site.
- A platform should be set up when working high above the ground.

1.1 Installation Positions of the outdoor unit

- (1). Avoid direct sunshine.
- (2). Outdoor unit must be installed on a firm and solid support.
- (3). Ensure the hanger rod, ceiling and building structure have sufficient strength to support the weight of air conditioner unit.
- (4). Avoid placing the outdoor unit under window or between two constructions, hence to prevent normal operating noise from entering the room.
- (5). Air flow at inlet and outlet shall not be blocked.
- (6). Install at a well-ventilated place, so that the machine can absorb and discharge sufficient air.
- (7). Do not install at a place where inflammable or explosive goods exist or a place subject to severe dust, salty fog and polluted air.

1.2 Installation Positions of the indoor unit

- (1) Avoid direct sunshine.
- (2) Ensure the hanger rod, ceiling and building structure have sufficient strength to support the weight of air conditioner unit.
- (3) Drainage pipe is easy to connect out.
- (4) Indoor and outdoor connection pipes are easy to go outdoors.
- (5) Do not install at a place where inflammable or explosive goods exist or inflammable or explosive gas might leak.
- (6) Do not install at a place subject to corrosive gas, severe dust, salty fog, smoke or heavy moisture.







1.3 Matters Need Attention

- (1) The installation of unit must be in accordance with national and local safety codes.
- (2) Installation quality will directly affect the normal use of air conditioner unit. The user is prohibited from installation by himself. Please contact your dealer after buying this machine. Professional installation workers will provide installation and test services according to installation manual.
- (3) Do not connect to power until all installation work is completed.





2 Filed Supplied Pipes and Valves

Name	Picture	Usage
Water Filter		It is used to remove foreign matters in the waterway.

Installation

2-way Valve		It is used to switch waterways between underfloor system and the FCU.
3-way Valve		It is used to switch waterways of hot water inside the water tank and circulation water inside the main unit.
Bypass Valve		It is used to balance the water pressure.
Water Trap		It is used to distribute water.
Pipe and Pipe Joint		It is used to connect the water pipes.
Cut-off Valve		It is used to cut off or get through the waterway.

3 Service Tools

Name	Picture
Spanner	
Screw Driver	
Pliers	
Tube Tongs	

4 Instalation Instructions

4.1 Installation Examples

CASE 1: Connecting Under-floor Coil for Heating and Cooling

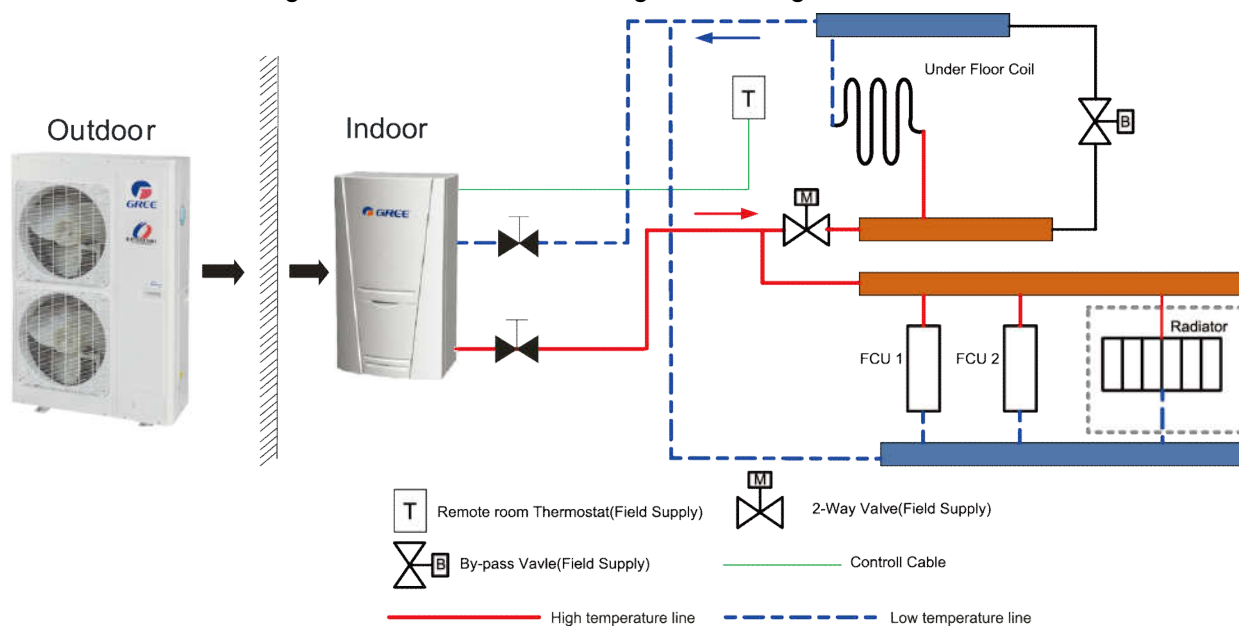

Note:

- The two-way valve is very important to prevent dew condensation on the floor and radiator while

cooling mode;

- Type of thermostat and specification should be complied with installation of this manual;
- The bypass valve must be installed to secure enough water flow rate, and should be installed at the collector.

CASE 2: Connecting Sanitary Water Tank

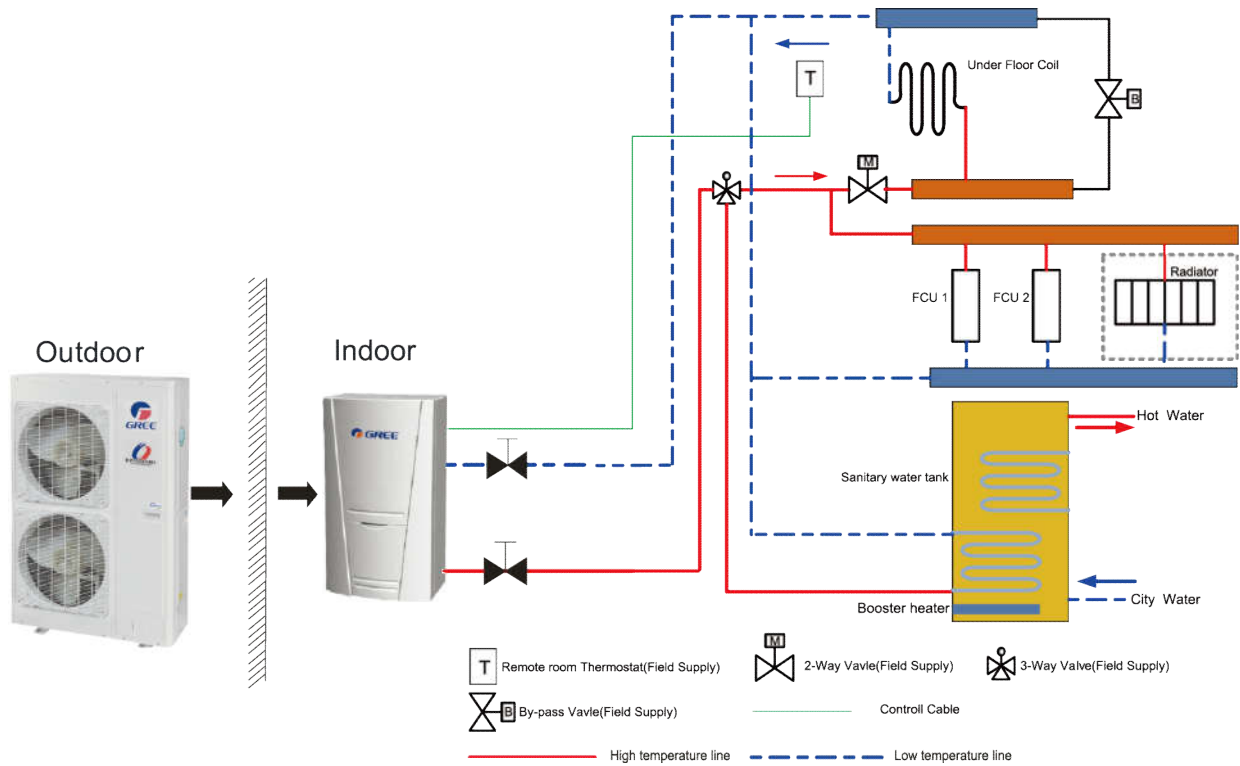

Note:

- . In this case, three-way valve should be installed and should be complied with installation of this manual;
- . Sanitary water tank should be equipped with internal electric heater to secure enough heat energy in the very cold days.

CASE 3 : Connecting Sanitary Water Tank and Heat Emitters for Heating and Cooling

Installation

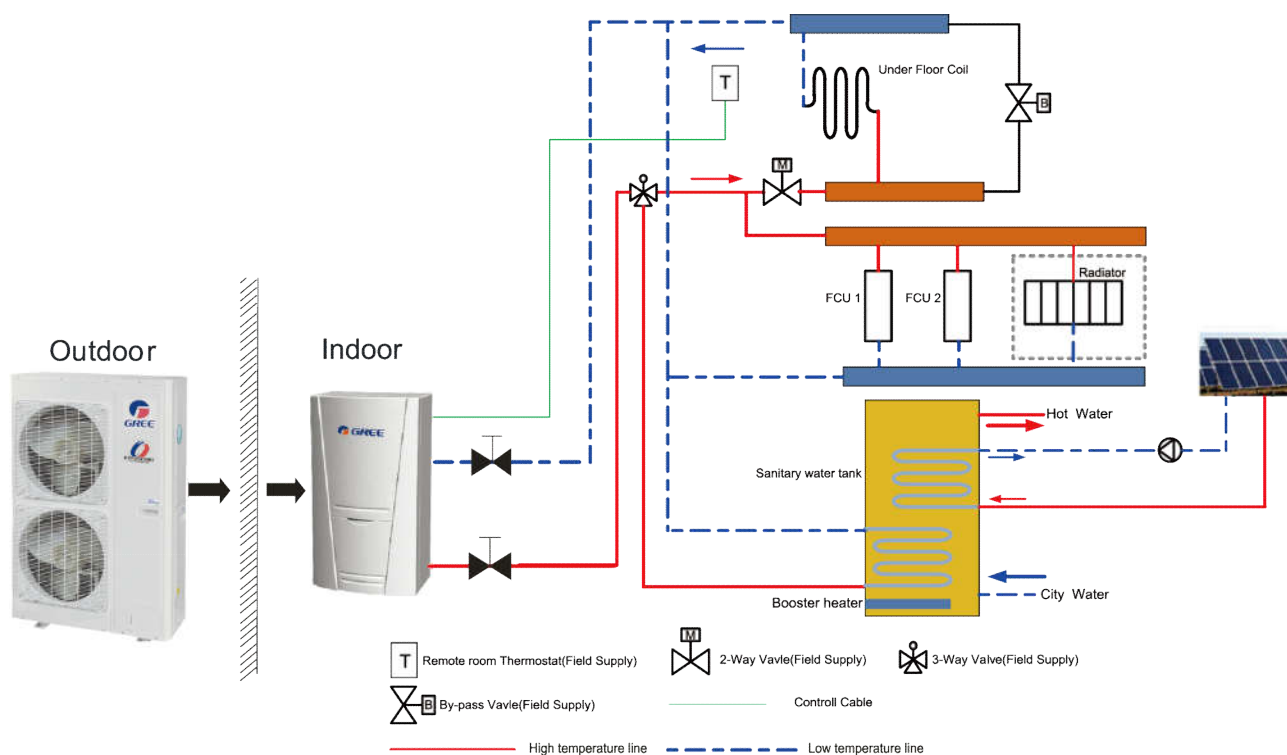

Two-way valve is very important to prevent dew condensation on the floor and radiator while cooling mode.

CASE 4 : Connecting Swimming pool system

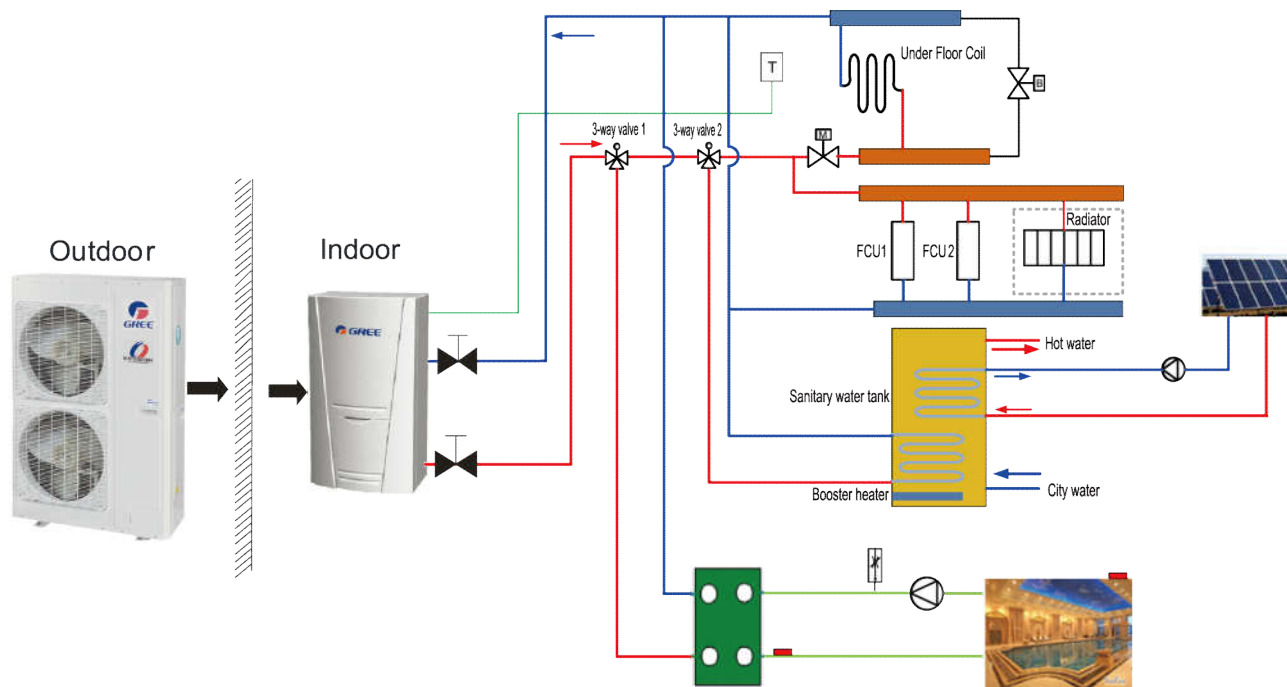

Note:

- . Two-way valve is very important to prevent dew condensation on the floor and radiator while cooling mode.
- . 3-Way valve 1 is controlled by user, while the pool pump is activated, 3-Way valve 1 switches to pool loop; while the pool pump is shut down, 3-Way valve 1 switches to under floor/FCU loop.
- . 3-Way valve 2 is automatic controlled by the unit, while running water heating mode, 3-Way valve 2 switches to water tank loop; while running cooling/heating mode, 3-Way valve 2 switches to under floor/FCU loop.

4.2 Pre-Installation

(1) Installation of the unit must be in accordance with national and local safety codes.

(2) Installation quality will directly affect the normal use of the air conditioner unit. The user is prohibited from installation by himself. Please contact your dealer after buying this machine. Professional installation workers will provide installation and test services according to the installation manual.

(3) Do not connect to power supply until all installation work is completed.

4.3 Selection of Installation Location

(1) The outdoor unit must be installed on a firm and solid support.

(2) Avoid placing the outdoor unit under window or between two constructions, hence to prevent normal operating noise from entering the room.

(3) Air flow at inlet and outlet shall not be blocked.

(4) Install at a well-ventilated place, so that the machine can absorb and discharge sufficient air.

(5) Do not install at a place where inflammable or explosive goods exist or a place subject to severe dust, salty fog and polluted air.

4.4 Outline Dimension of Outdoor Unit

- ◆ GRS-CQ8.0Pd/NaD-K(O),GRS-CQ10Pd/NaD-K(O)

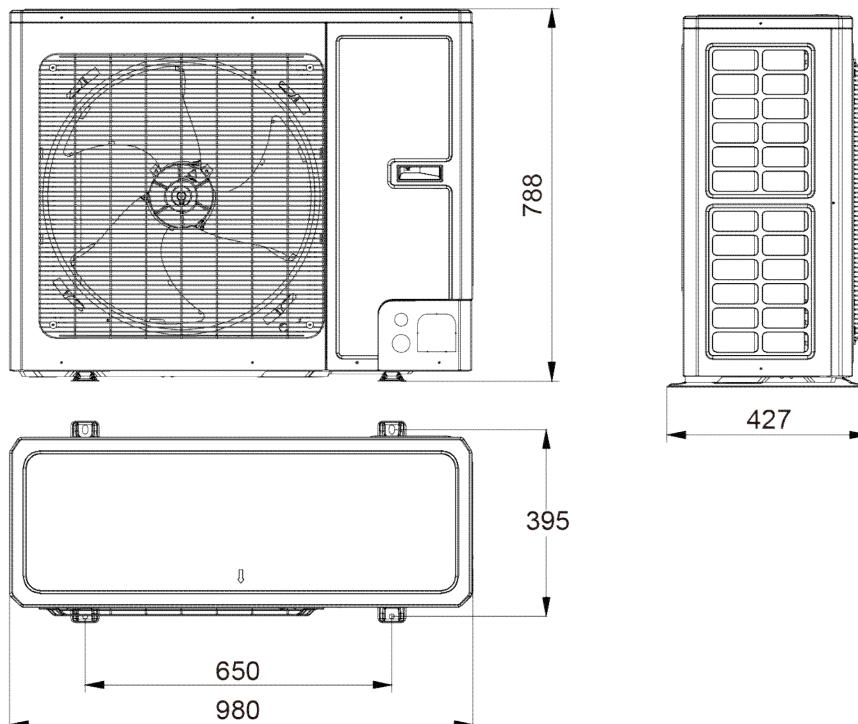

- ◆ GRS-CQ12Pd/NaD-M(O),GRS-CQ14Pd/NaD-M(O)

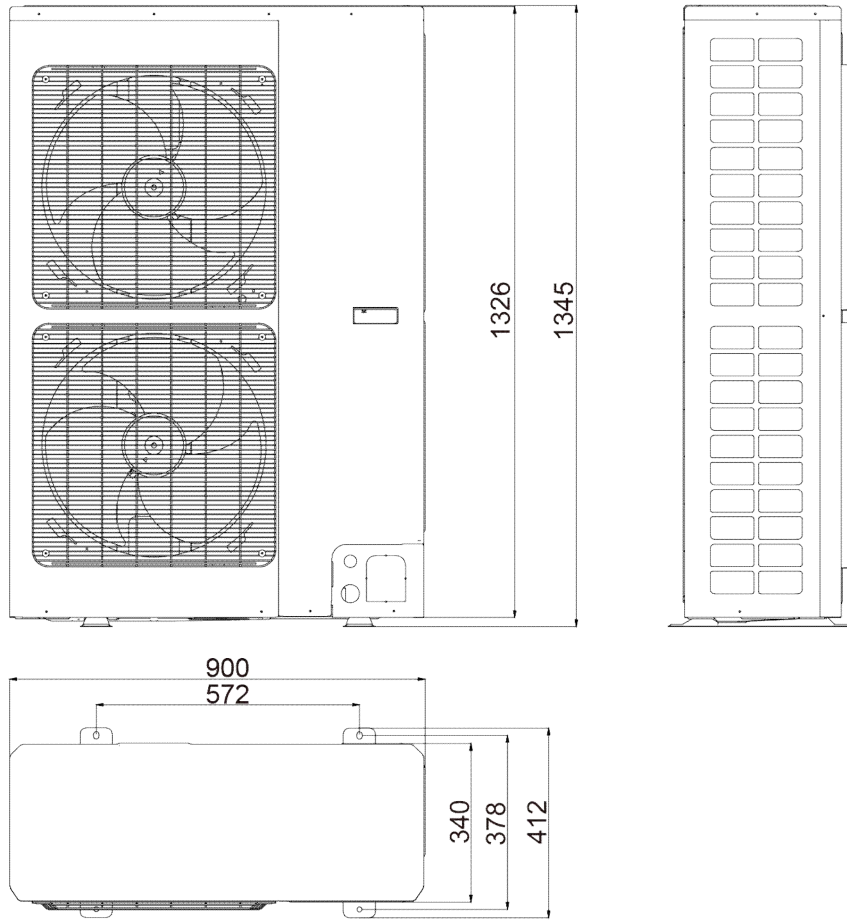

Description:

Unit: inch

No.	Name	Remarks	
1	Liquid-side Service Valve	3/8	GRS-CQ8.0/10Pd/NaD-K, GRS-CQ12/14Pd/NaD-M
2	Gas-side Service Valve	5/8	GRS-CQ8.0/10Pd/NaD-K, GRS-CQ12/14Pd/NaD-M
3	Handle	Used to cover or uncover the front case	
4	Air discharge Grill	/	

4.5 Installation Clearance Data

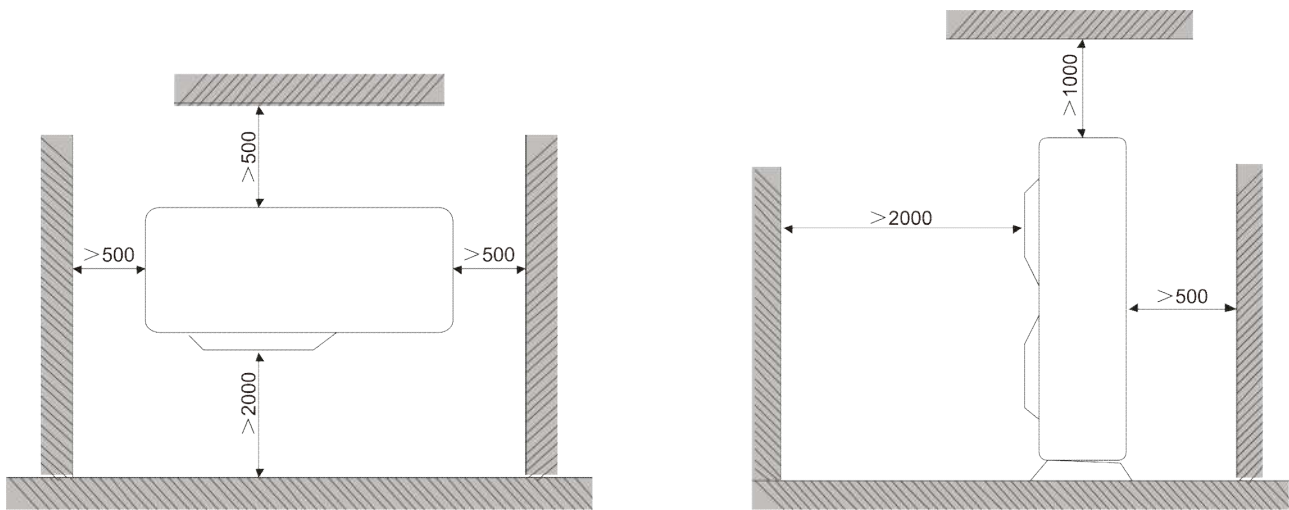

(1) When moving the outdoor unit, it is necessary to adopt 2 pieces of long enough rope to hand the unit from 4 directions. Included angle between the rope when hanging and moving must be 40° below to prevent center of the unit from moving.

- (2) The outdoor unit should be installed on concrete base that is 10cm height.
- (3) Requirements on installation space dimension of unit's bodies are shown in following drawing.
- (4) The outdoor unit must be lifted by using designated lifting hole. Take care to protect the unit during lift. To avoid rusting, do not knock the metal parts.

4.6 Outline Dimension of Indoor Unit

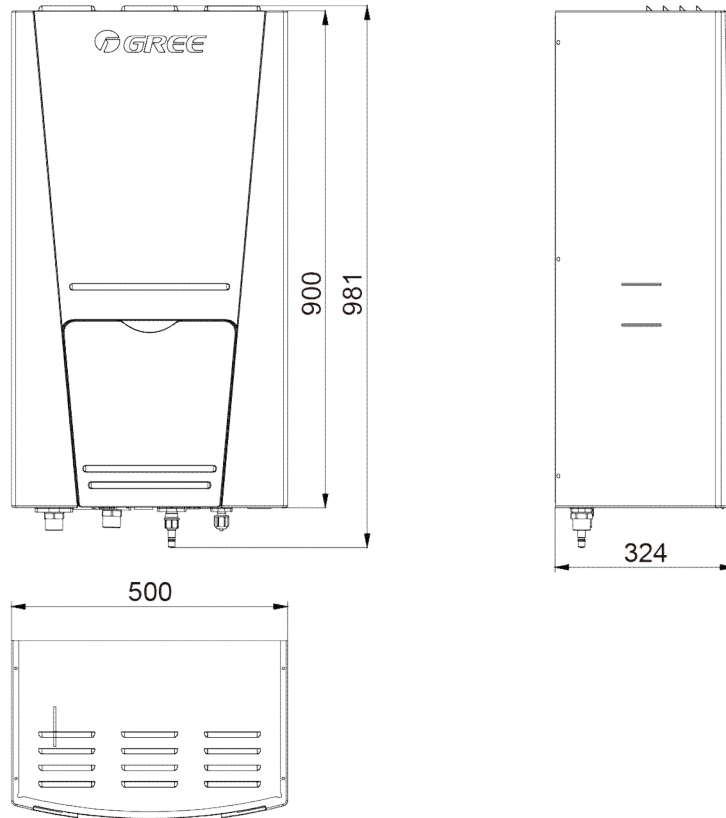

Description:

Unit: inch

No.	Name	Remarks	
1	Leaving Water Pipe	1"Male BSP	
2	Returning Water Pipe	1"Male BSP	
3	Gas-side Pipe	5/8	GRS-CQ8.0/10Pd/NaD-K, GRS-CQ12/14Pd/NaD-M
4	Liquid-side Pipe	3/8	GRS-CQ8.0/10Pd/NaD-K, GRS-CQ12/14Pd/NaD-M

4.7 Installation Clearance Data

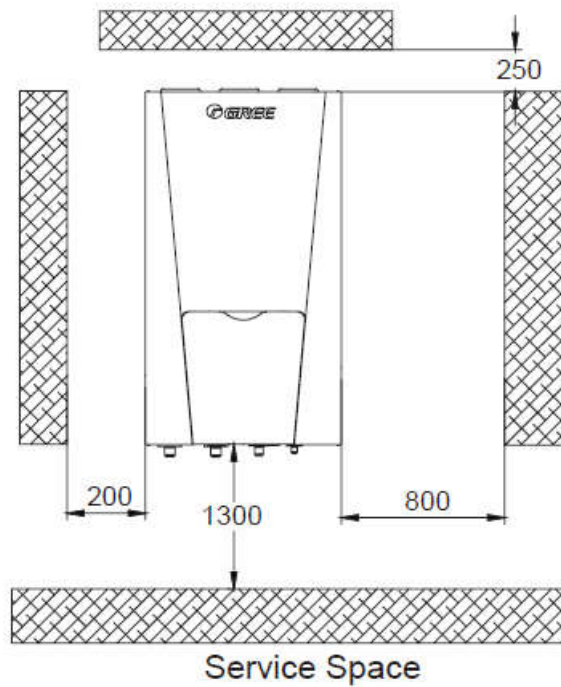

(1) Indoor unit shall be vertically mounted on the wall of the room with expansion bolt.

(2) Keep the indoor unit away from heat sources like heat sink and so on in the room as much as possible.

(3) Keep the indoor unit as close as possible to outdoor unit. Level distance between connection pipes cannot exceed 30m (8.0~14kW) and vertical distance cannot exceed 15m (8.0~14kW).

4.8 Electric Wiring

(1) Wiring diagram: indoor unit

- ◆ GRS-CQ8.0Pd/NaD-K(I),GRS-CQ10Pd/NaD-K(I)

Installation

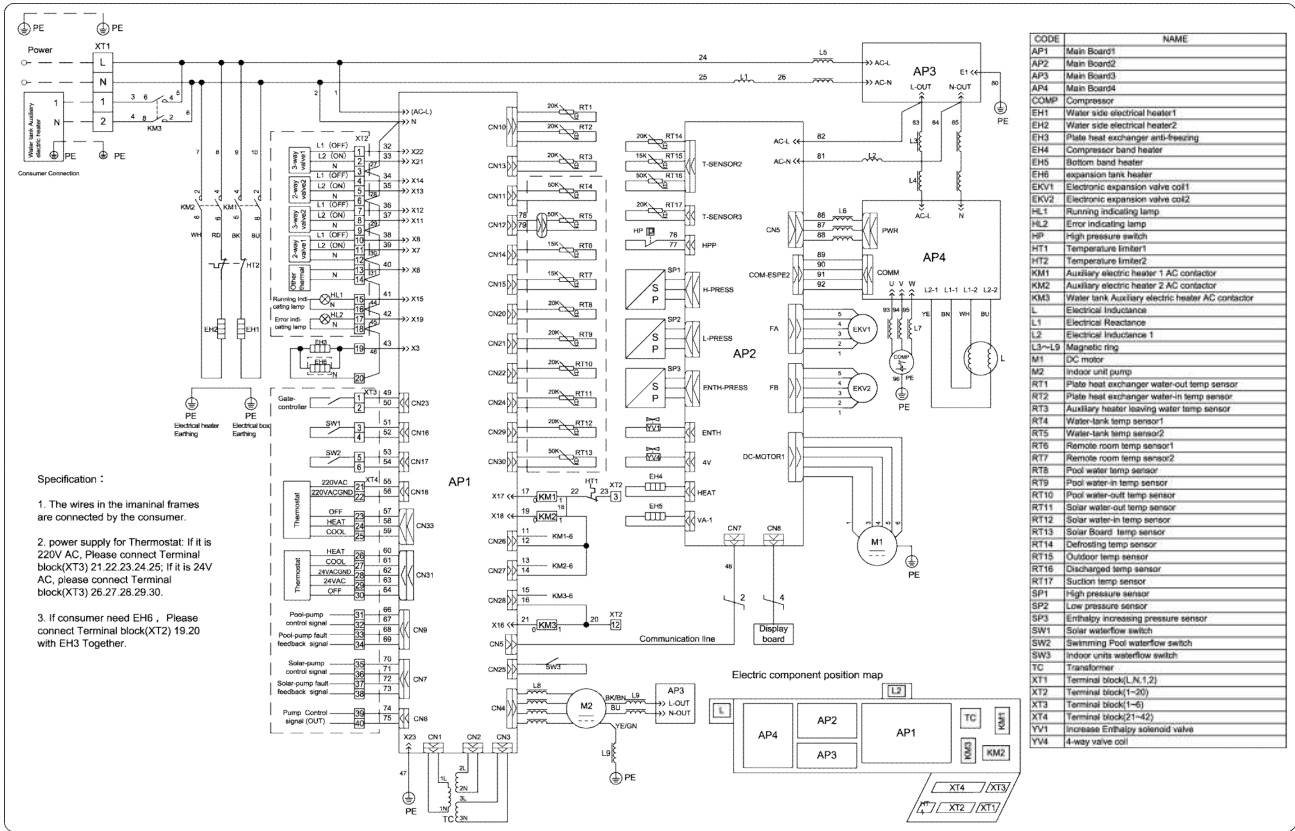

◆ GRS-CQ12Pd/NaD-M(I),GRS-CQ14Pd/NaD-M(I)

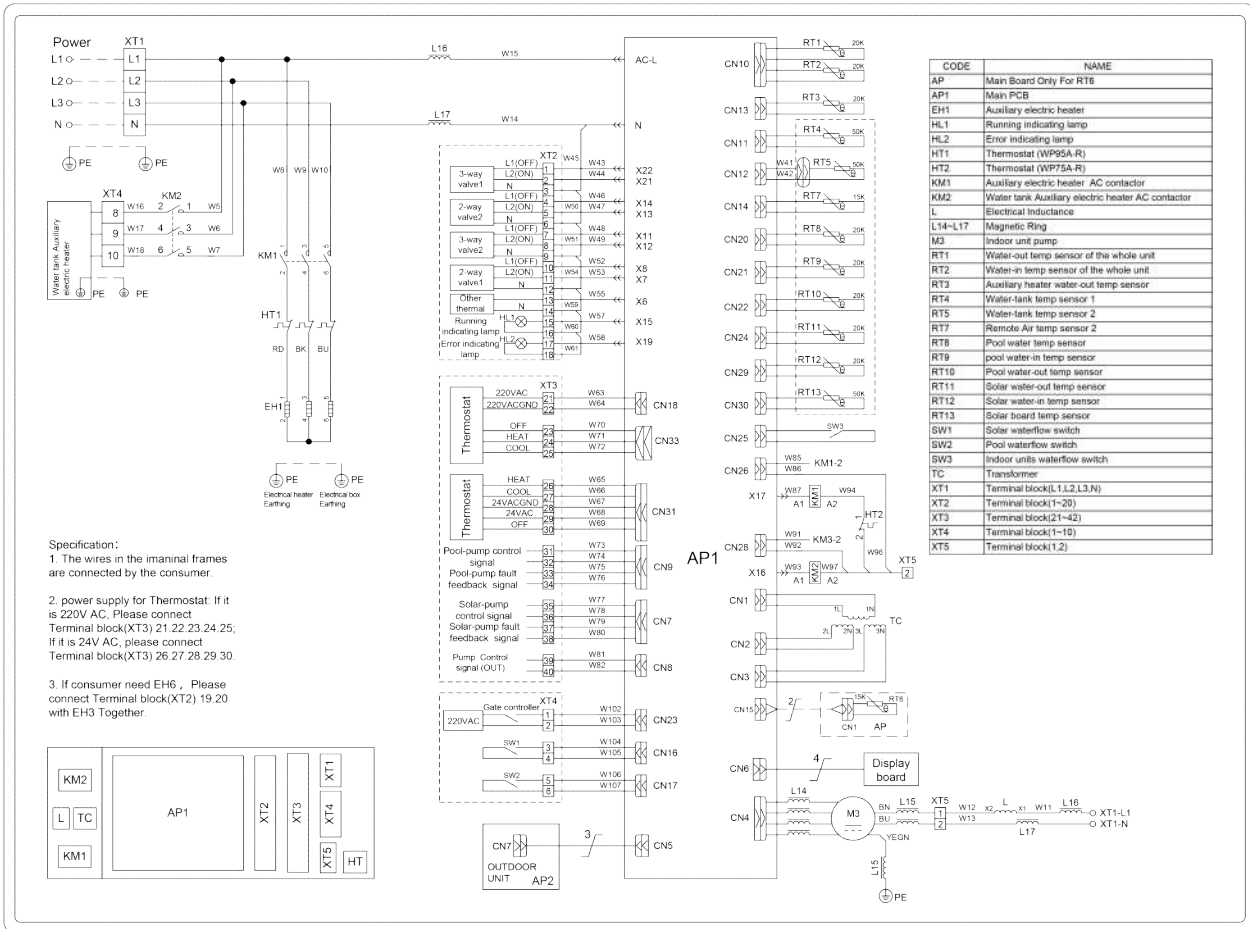

(2) Wiring diagram: outdoor unit

Installation

◆ GRS-CQ8.0Pd/NaD-K(O),GRS-CQ10Pd/NaD-K(O)

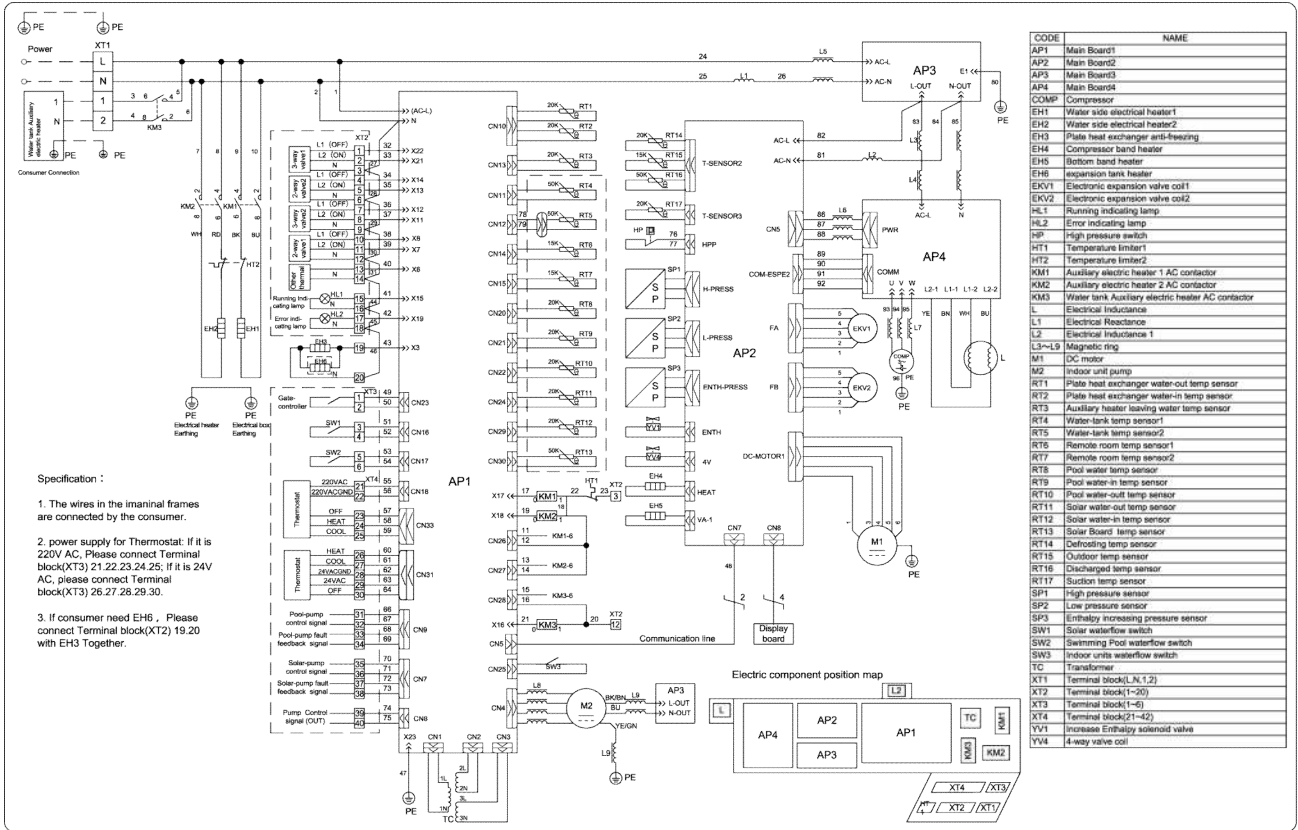

◆ GRS-CQ12Pd/NaD-M(O),GRS-CQ14Pd/NaD-M(O)

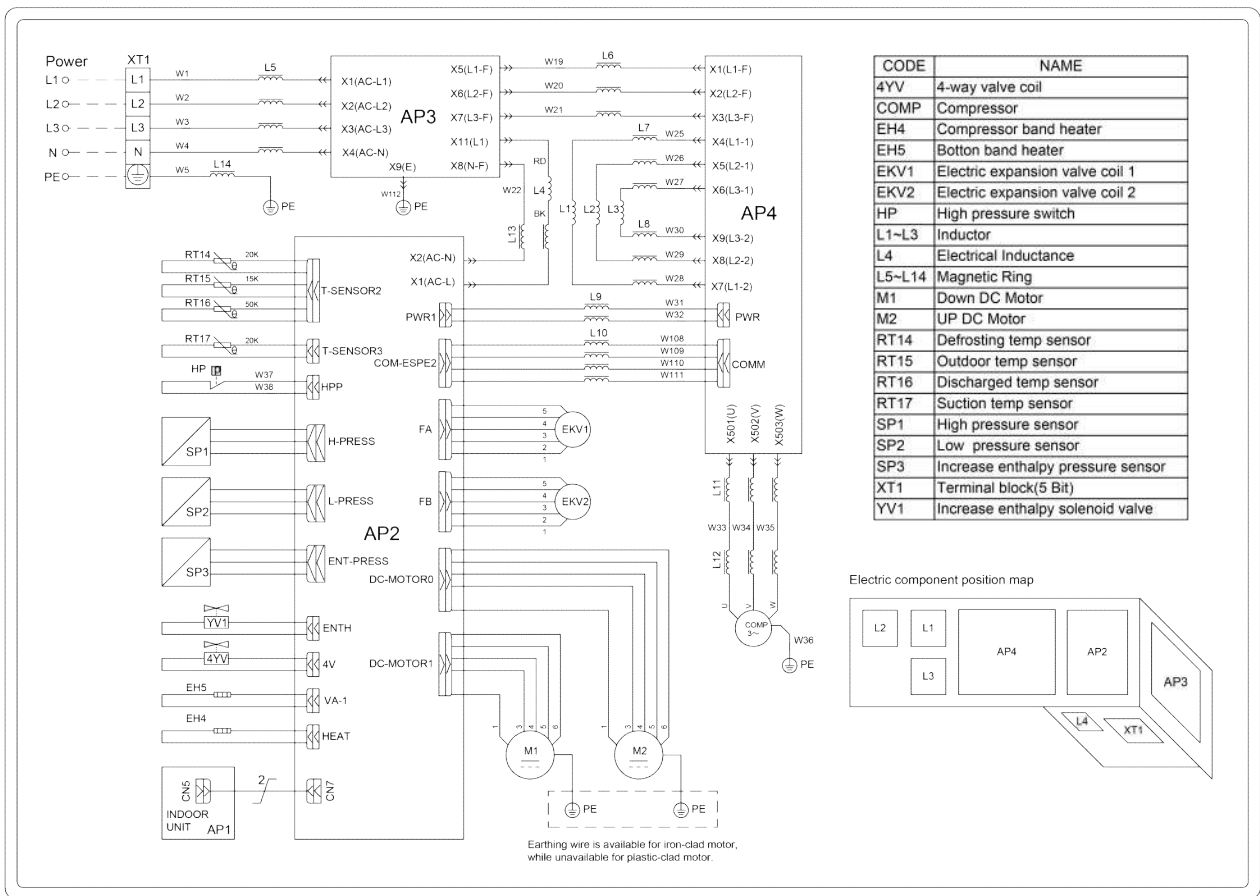

4.9 Wiring of the Terminal Board

◆ GRS-CQ8.0Pd/NaD-K, GRS-CQ10Pd/NaD-K

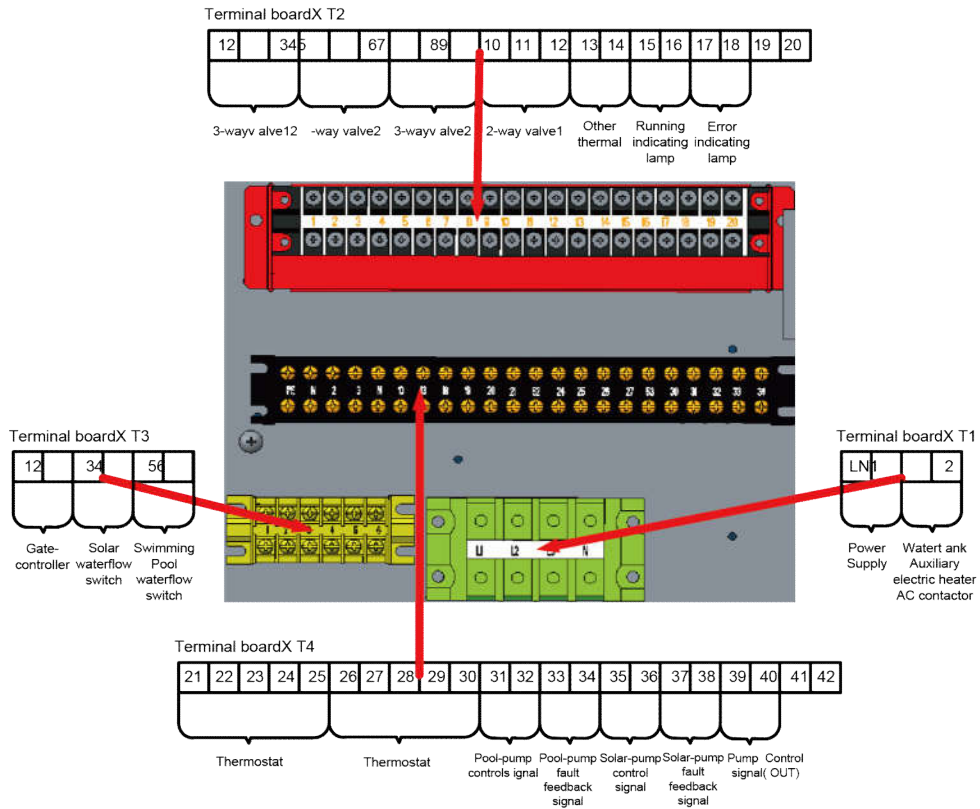

◆ GRS-CQ12Pd/NaD-M, GRS-CQ14Pd/NaD-M

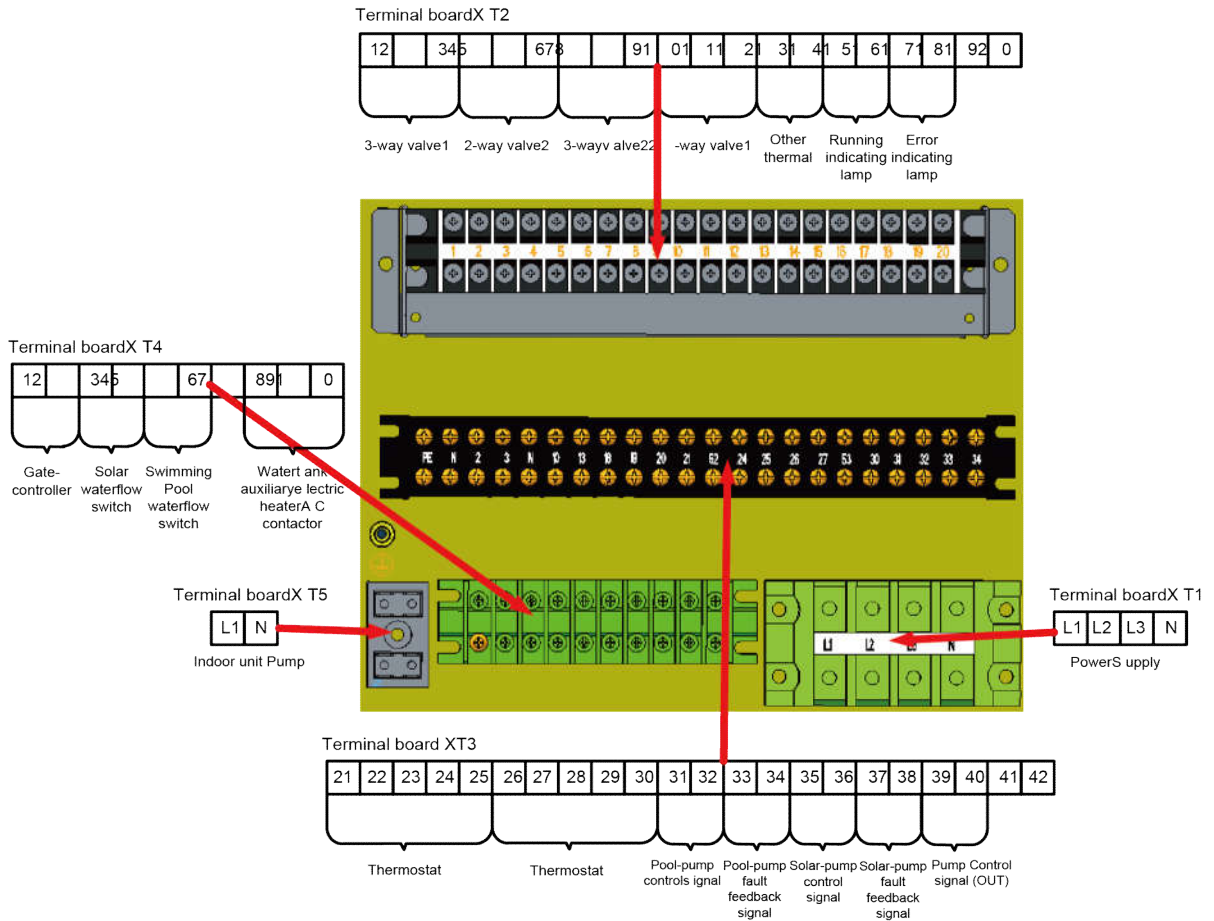

4.10 Wiring of the 2-Way Valve

There are two 2-way valve, the 2-way valve 1 is available and the 2-way valve 2 is reserved. The 2-way valve 1 is required to control water flow for cooling or heating operation. The role of 2-way valve 1 is to cut off water flow into the underfloor loop when the fan coil unit is equipped for cooling operation.

General Information

Type	Power	Operating Mode	Supported
NO 2-wire	230V 50Hz ~AC	Closing water flow	Yes
		Opening water flow	Yes
NC 2-wire	230V 50Hz ~AC	Closing water flow	Yes
		Opening water flow	Yes

(1) Normal Open type. When electric power is NOT supplied, the valve is open. (When electric power is supplied, the valve is closed.)

(2) Normal Closed type. When electric power is NOT supplied, the valve is closed. (When electric power is supplied, the valve is open.)

How to Wire 2-Way Valve:

Follow steps below to wire the 2-way valve.

Step 1. Uncover the front cover of the unit and open the control box.

Step 2. Find the terminal block and connect wires as below.

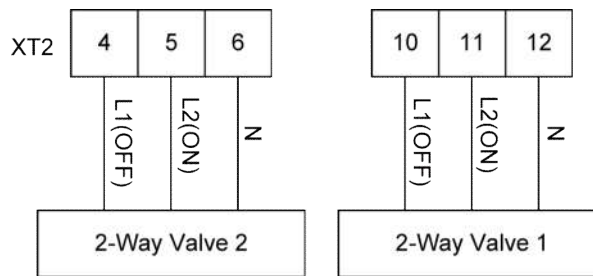

⚠ WARNING!

- Normal Open type should be connected to wire (ON) and wire (N) for valve closing in cooling mode.
- Normal Closed type should be connected to wire (OFF) and wire (N) for valve closing in cooling mode.

(ON) : Line signal (for Normal Open type) from PCB to 2-way valve

(OFF) : Line signal (for Normal Closed type) from PCB to 2-way valve

(N) : Neutral signal from PCB to 2-way valve

The 2-way valve 2 is reserved without any control program. At the field installation, it should be wired at the terminal board of the 2-way valve 2.

4.11 Wiring of Other Auxiliary Heat Sources

Other auxiliary heat sources are allowed for the equipment and controlled in such a way that the mainboard will output 230V when outdoor temperature is lower than the set point for startup of the auxiliary heat source.

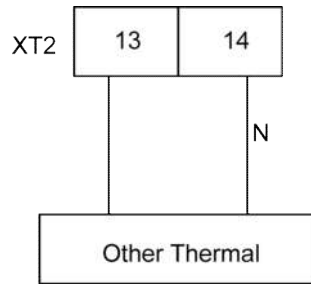

4.12 Wiring of the Gate-Controller

If there is gate control function, installation guide follow as:

(1) GRS-CQ8.0Pd/NaD-K, GRS-CQ10Pd/NaD-K

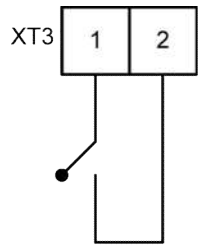

Gate-Controller

(2) GRS-CQ12Pd/NaD-M, GRS-CQ14Pd/NaD-M

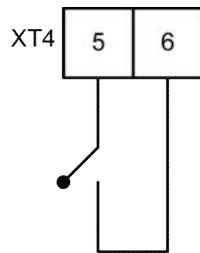

Gate-Controller

4.13 Wiring of the Remote Air Temperature Sensor



Front side



Back side

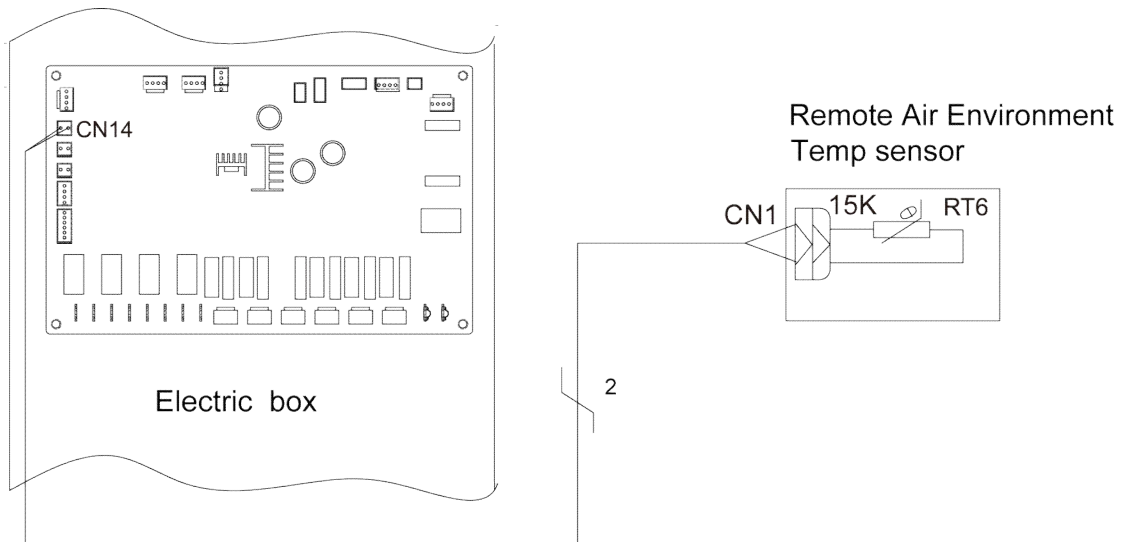
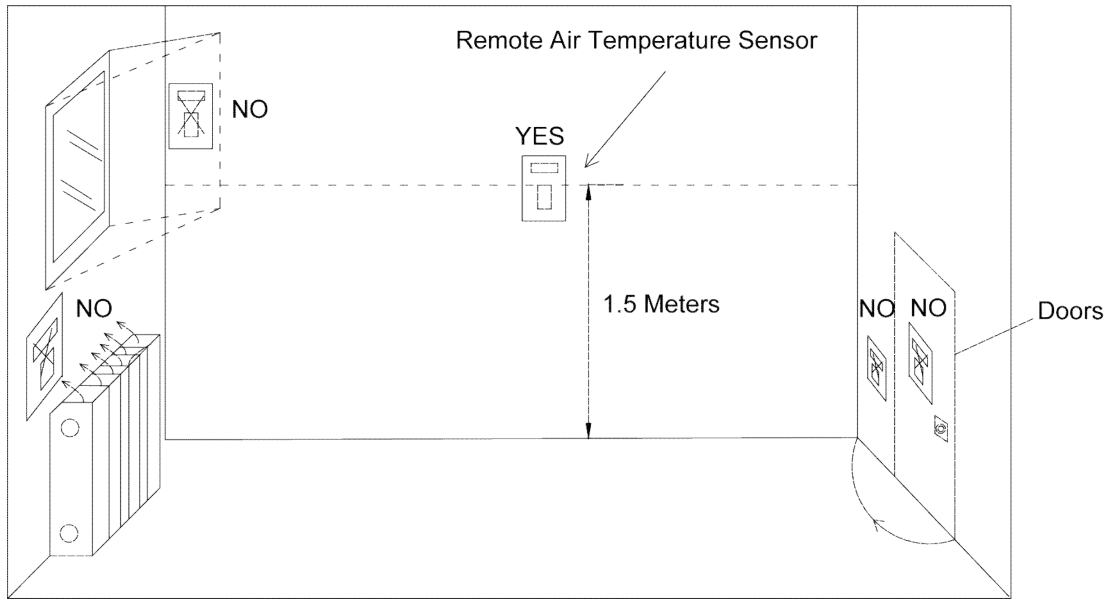

Note:

- ① Distance between the indoor unit and the remote air temperature sensor should be less than 15m due to length of the connection cable of remote air temperature sensor;
- ② Height from floor is approximately 1.5m;
- ③ Remote air temperature sensor cannot be located where the area may be hidden when door is open;

- ④ Remote air temperature sensor cannot be located where external thermal influence may be applied;
- ⑤ Remote air temperature sensor should be installed where space heating is mainly applied;
- ⑥ After the remote air temperature sensor is installed, it should be set to “With” through the wired controller so as to set the remote air temperature to the control point.

4.14 Wiring of the Thermostat

Installation of the thermostat is very similar to that of the remote air temperature sensor.

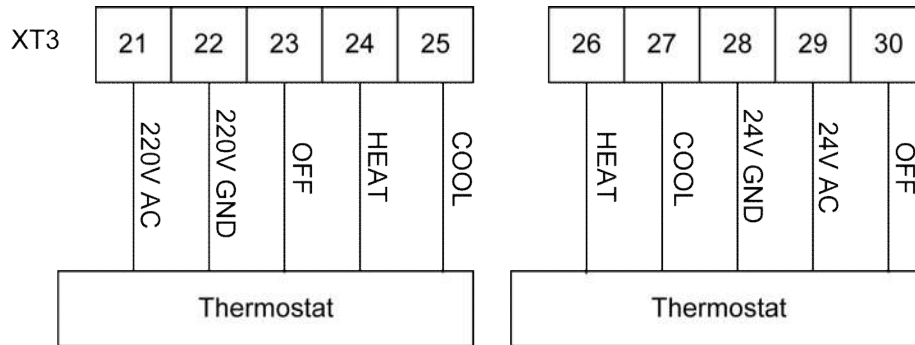

How to Wire Thermostat

- (1) Uncover the front cover of indoor unit and open the control box;
- (2) Identify the power specification of the thermostat, if it is 230V, find terminal block XT3 as NO.21~25; Otherwise, if it is 24V, find terminal block XT3 as NO.26~30;
- (3) If it is the heating/cooling thermostat, please connect wire as per the figure above.

⚠ CAUTION!

- ① Never use 230V AC and 24V AC thermostat at the same time, otherwise, it will cause short circuit and power cut-off by the circuit breaker;
- ② Setting temperature by the thermostat(heating or cooling) should be within the temperature range of the product ;
- ③ For other constrains, please refer to previous pages about the remote air temperature sensor;
- ④ Do not connect external electric loads. Wire 220V AC(24V AC) and 220V GND(24V GND) should be used only for the electric thermostat;
- ⑤ Never connect external electric loads such as valves, fan coil units, etc. If connected, the mainboard of the unit can be seriously damaged;
- ⑥ Installation of the thermostat is very similar to that of the remote air temperature sensor.

4.15 Wiring of the Control

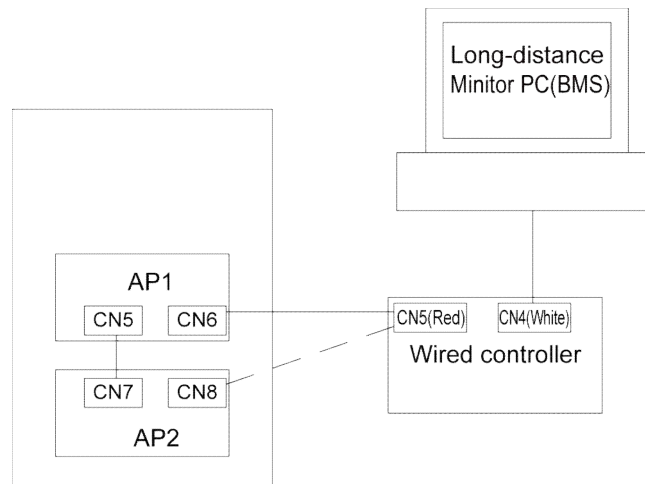

Note:

- ① The wired controller can be connected to the terminal of AP1 CN6 or AP2 CN 8 through the four-wire communication line.
- ② AP1 (CN 5) and AP2 (CN 7) have been connected with the communication line (three-wire communication line before delivery).
- ③ The remote monitoring device can be connected to the CN4 of the wired controller through a four-wire communication line.

5 Commissioning and Trial Run

5.1 Check before startup

For safety of users and unit, the unit must be started up for check before debugging. The procedures are as below:

The following items shall be performed by qualified repair persons.		
Confirm together with the sales engineer, dealer, installing contractor and customers for the following items finished or to be finished.		
No.	Confirmation of Installation	√
1	If the contents of Application for Installation of this Unit by Installer are real. If not, debugging will be refused.	<input type="checkbox"/>
2	Is there written notice in which amendment items are shown in respect of unqualified installation?	<input type="checkbox"/>
3	Are Application for Installation and Debugging list filed together?	<input type="checkbox"/>
No.	Pre-check	√
1	Is appearance of the unit and internal pipeline system ok during conveying, carrying or installation?	<input type="checkbox"/>
2	Check the accessories attached with the unit for quantity, package and so on.	<input type="checkbox"/>
3	Make sure there is drawings in terms of electricity, control, design of pipeline and so on.	<input type="checkbox"/>
4	Check if installation of the unit is stable enough and there is enough space for operation and repair.	<input type="checkbox"/>
5	Completely test refrigerant pressure of each unit and perform leakage detection of the unit.	<input type="checkbox"/>
6	Is the water tank installed stably and are supports secure when the water tank is full?	<input type="checkbox"/>

Installation



7	Are heat insulating measures for the water tank, outlet/inlet pipes and water replenishing pipe proper?	<input type="checkbox"/>
8	Are the nilometer of water tank, water temperature indicator, controller, manometer, pressure relief valve and automatic discharge valve etc. installed and operated properly?	<input type="checkbox"/>
9	Does power supply accord with the nameplate? Do power cords conform to applicable requirements?	<input type="checkbox"/>
10	Is power supply and control wiring connected properly according to wiring diagram? Is earthing safe? Is each terminal stable?	<input type="checkbox"/>
11	Are connection pipe, water pump, manometer, thermometer, valve etc. are installed properly?	<input type="checkbox"/>
12	Is each valve in the system open or closed according to requirements?	<input type="checkbox"/>
13	Confirm that the customers and inspection personnel of Part A are at site.	<input type="checkbox"/>
14	Is Installation Check-up Table completed and signed by the installation contractor?	<input type="checkbox"/>

Attention: If there is any item marked with ×, please notify the contractor. Items listed above are just for reference.

Confirmed Items after pre-checking	General Evaluation: Debugging <input type="checkbox"/> Amendment <input type="checkbox"/>	
	Judge the following items (if there is not any filling, qualification will be regarded.)	
	a: Power supply and electric control system	b: Loading calculation
	c: Heating problems of Unit	d: Noise problem
	e: Pipeline problem	f: Others
	Normal debugging work can't be performed unless all installation items are qualified. If there is any problem, it must be solved firstly. The installer will be responsible for all costs for delay of debugging and re-debugging incurred by any problem which is not solved immediately.	
	Submit schedule of amending reports to installer.	
	Is the written amending report which should be signed after communication provided to installer?	
	Yes () No ()	

5.2 Test run

Test run is testing whether the unit can run normally via preoperation. If the unit cannot run normally, find and solve problems until the test run is satisfactory. All inspections must meet the requirements before performing the test run. Test run should follow the content and steps of the table below:

The following procedure should be executed by experience and qualified maintenance men.	
No.	Start up the pretest procedure
Notice: before test, ensure that all power must be cut off, including the far- end power switch, otherwise, it may cause casualty.	
1	Ensure that the compressor of the unit is preheated for 8h.
 Caution: heat the lubricating oil at least 8h in advance to prevent refrigerant from mixing with the lubricating oil, which may cause damage to the compressor when starting up the unit.	
2	Check whether the oil temperature of the compressor is obviously higher than the outdoor ambient temperature.
 Caution: if the oil temperature of the compressor is obviously higher than the outdoor ambient temperature, it means that the heating tape of compressor is damaged. In that case, the compressor will be damaged easily. Therefore, repair the heating tape before using the unit.	
3	Check whether the phase sequence of the main power supply is correct. If not, correct the phase sequence firstly.

Installation

⚠ Recheck the phase sequence before start-up to avoid reverse rotation of the compressor which may damage the unit.	
4	Apply the universal electric meter to measure the insulation resistance between each outdoor phase and earth as well as between phases.
⚠ Caution: defective earthing may cause electric shock.	
No.	Ready to start
1	Cut off all temporary power supply, resume all the insurance and check the electricity for the last time.
	Check the power supply and voltage of the control circuit; _____V must be $\pm 10\%$ within the range of rated operating power.
No.	Start up the unit
1	Check all the conditions needed to start up the unit: oil temperature, mode, required load etc.
2	Start up the unit, and observe the operation of compressor, electric expanding valve, fan motor and water pump etc.
	Note: the unit will be damaged under abnormal running state. Do not operate the unit in states of high pressure and high current.
Others:	
Items for acceptance after debugging	Estimation or suggestion on the general running situation: good, modify
	Identify the potential problem (nothing means the installation and debugging are in accordance with the requirements.)
	a. problem of power supply and electric control system:
	b. problem of load calculation:
	c. outdoor refrigerant system:
	d. noise problem:
	e. problem of indoor and piping system:
	h. other problems:
During operation, it is needed to charge for the maintenance due to non-quality problems such as incorrect installation and maintenance.	
Acceptance	
Is the user trained as required? Please sign. Yes() No()	

Test Operation & Troubleshooting & Maintenance

1 Trial Run

1.1 Check for Wiring

WARNING!

Do not check for the power supply unless proper checkout equipment has prepared and preventive measures have been taken, otherwise it would lead to severe injury.

- ◆ Are sizes of connection lines and the air switch proper?
- ◆ Does wiring comply with relative standards and electric codes?
- ◆ Is there any incorrect wiring?
- ◆ Does each contact work properly?
- ◆ Is the power supply and insulation proper?
- ◆ Are initial set points of control and protective elements satisfied?

1.2 Check for the Water System

- ◆ Are water inlet and outlet directions correct?
- ◆ Is the water piping cleaned? Are there foreign matters at the pipe joints? Is the water quality satisfied?
- ◆ Is insulation of water pipes in good condition?
- ◆ Does exhaust valve of the water system work properly?

1.3 Check for the Communication System

When the unit is powered on, check for the communication system, including: communication between AP1 and AP2, between the wired controller and the main board. When there is unusual communication, this error will be displayed at the wired controller. Then, check out the cause according to the displayed error. See the figure below for wiring of the communication system.

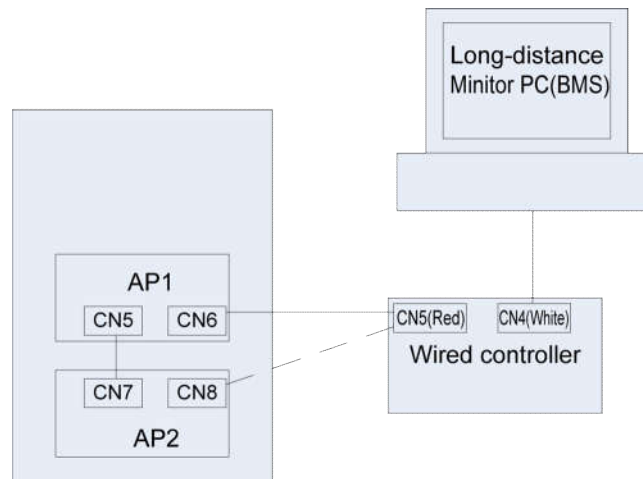

1.4 Trial Run

Start the unit when there is no any problem for wiring and piping. After startup, check for the electrostatic expansion valve, water pump, fan, and compressor to see if they work normally. When there is any error, solve it according to the troubleshooting flowchart covered in this manual. However, if

the troubleshooting flowchart is still unhelpful, please contact GREE sales agent.

2 Error Code List

No.	Full Name	Displayed Name	Error Code
1	Ambient temperature sensor error	Ambient sensor	F4
2	Defrost temperature sensor error	Defro. sensor	d6
3	Discharge temperature sensor error	Disch. sensor	F7
4	Suction temperature sensor error	Suction sensor	F5
5	Outdoor fan error	Outdoor fan	EF
6	Compressor internal overload protection	Comp. overload	H3
7	High pressure protection	High pressure	E1
8	Low pressure protection	Low pressure	E3
9	High discharge protection	Hi-discharge	E4
10	Refrigerant loss protection	Refri-loss	P2
11	Heat pump-water pump protection	HP-pump	E0
12	Solar kit-water pump protection	SL-pump	EL
13	Swimming pool-water pump protection	Swimming-pump	
14	Incorrect capacity DIP switch setting	Capacity DIP	c5
15	Communication error between indoor and outdoor unit	ODU-IDU Com.	E6
16	Drive communication error	Drive com.	
17	High pressure sensor error	HI-pre. sens.	Fc
18	Enthalpy-enhancing sensor error	En. senser	F8
19	Low pressure sensor error	LOW-pre. Sens.	dL
20	Heat exchanger-leaving water temperature sensor error	Temp-HELW	F9
21	Auxiliary heater-leaving water temperature sensor error	Temp-AHLW	dH
22	Heat exchanger-entering water temperature sensor error	Temp-HEEW	
23	Water tank water temperature sensor 1 error	Tank sens. 1	FE
24	Water tank water temperature sensor 2 error	Tank sens. 2	
25	Solar kit-entering water temp sensor	T-SL water out	
26	Solar kit-leaving water temp sensor	T-SL water in	FH
27	Solar kit- temp sensor	T-Solar pannel	FF
28	Swimming pool-entering water temp sensor	T-Swimming in	
29	Swimming pool-leaving water temp sensor	T-Swimming out	
30	Swimming pool-water temp sensor	T-Swimming	
31	Remote room sensor 1	T-Remote Air1	F3
32	Remote room sensor 2	T-Remote Air2	
33	Heat pump-water flow switch	HP-Water SW	Ec
34	Solar kit-water flow switch	SL-Water SW	F2
35	Swimming pool-water flow switch	SW-Water SW	F1
36	Welding protection of the auxiliary heater 1	Auxi. heater 1	EH
37	Welding protection of the auxiliary heater 2	Auxi. heater 2	EH

Test Operation & Troubleshooting & Maintenance

38	Welding protection of the water tank heater	Auxi. -WTH	EH
39	Under-voltage DC bus or voltage drop error	DC under-vol.	PL
40	Over-voltage DC bus	DC over-vol.	PH
41	AC current protection (input side)	AC curr. pro.	PA
42	IPM defective	IPM defective	H5
43	PFC defective	FPC defective	Hc
44	Start failure	Start failure	Lc
45	Phase loss	Phase loss	LD
46	Drive module resetting	Driver reset	P6
47	Compressor over-current	Com. over-cur.	P0
48	Overspeed	Overspeed	P5
49	Sensing circuit error or current sensor error	Current sen.	LF
50	Desynchronizing	Desynchronize	Pc
51	Compressor stalling	Comp. stalling	H7
52	Communication error	drive-main com.	LE
53	Radiator or IPM or PFC module overtemperature	Overtemp.-mod.	P8
54	Radiator or IPM or PFC module temperature sensor error	T-mod. sensor	P7
55	Charging circuit error	Charge circuit	Pu
56	Incorrect AC voltage input	AC voltage	PP
57	Drive board temperature sensor error	Temp-driver	PF
58	AC contactor protection or input zero crossing error	AC contactor	P9
59	Temperature drift protection	Temp. drift	PE
60	Current sensor connection protection (current sensor not connected to phase U/V)	Sensor con.	PD
61	Communication error to the outdoor unit	ODU Com.	E6
62	Communication error to the indoor unit	IDU Com.	E6
63	Communication error to the drive	Driver Com.	E6
64	Solar kit-superheating	Solarsuperheat	F6

3 Flow Chart Of Troubleshooting

3.1 Comp High-pressure Protection E1

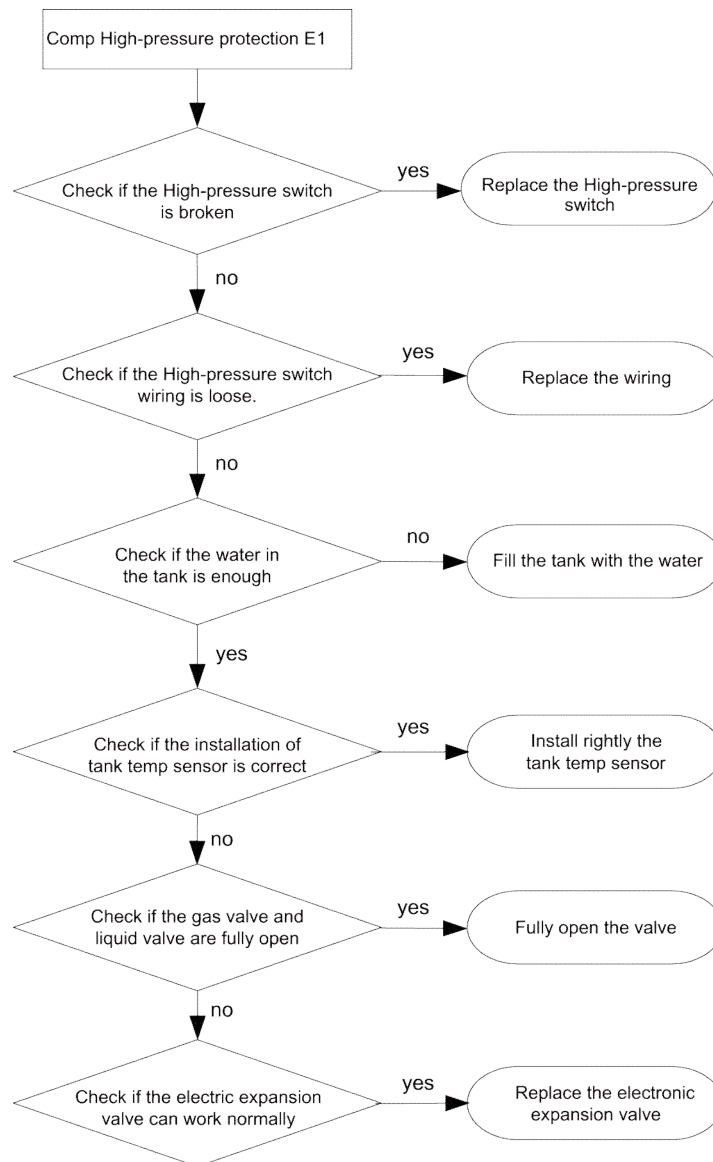

3.2 Comp Low- pressure Protection E3

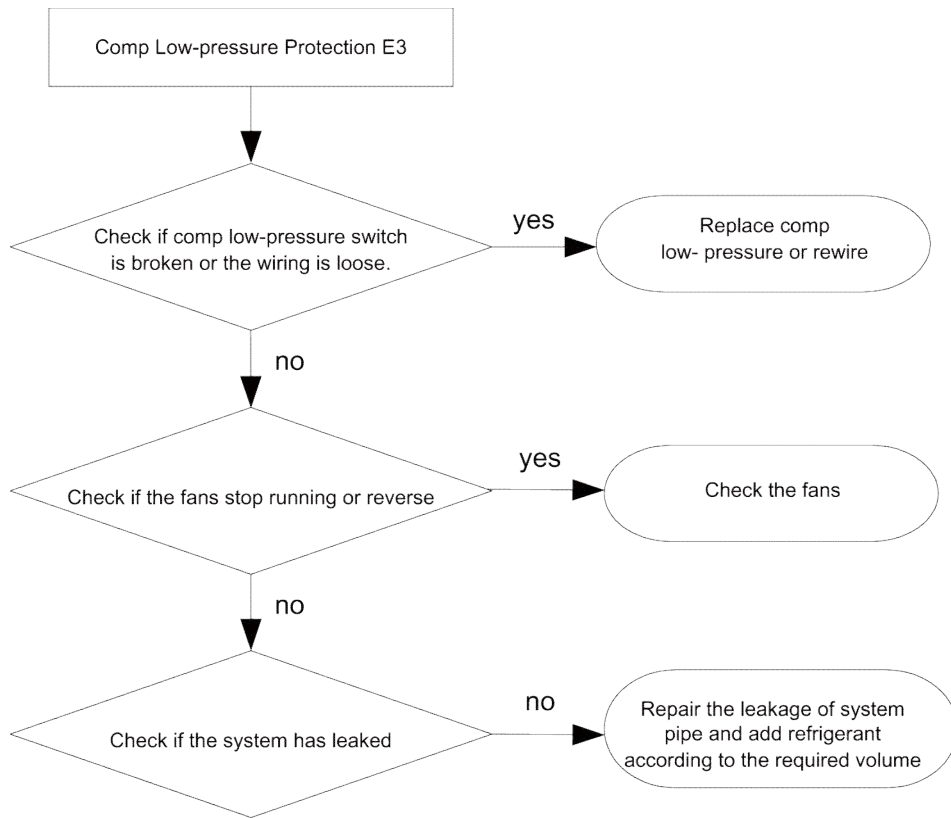

3.3 Comp Discharge Temp Protection E4

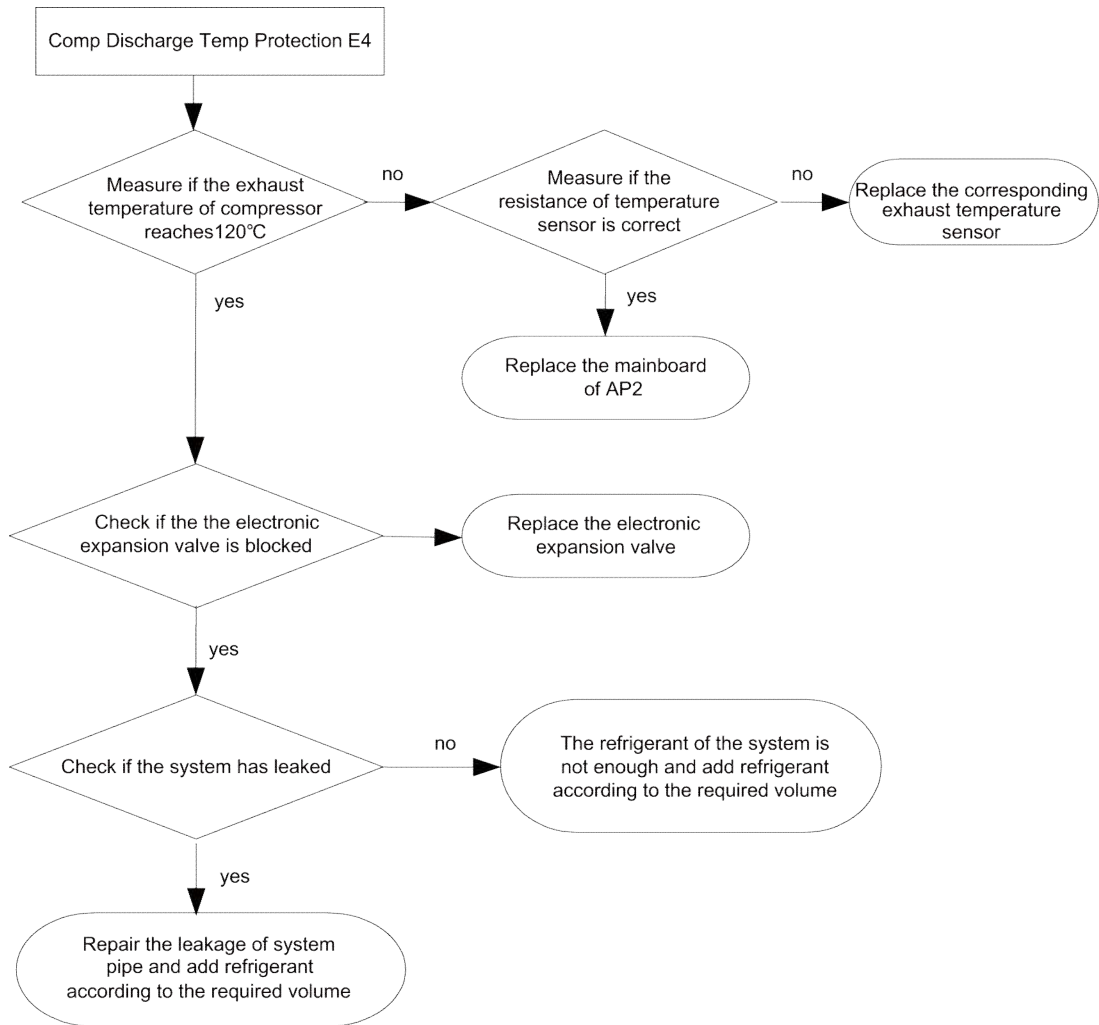

3.4 Overload Protection of Compressor or Driver Error

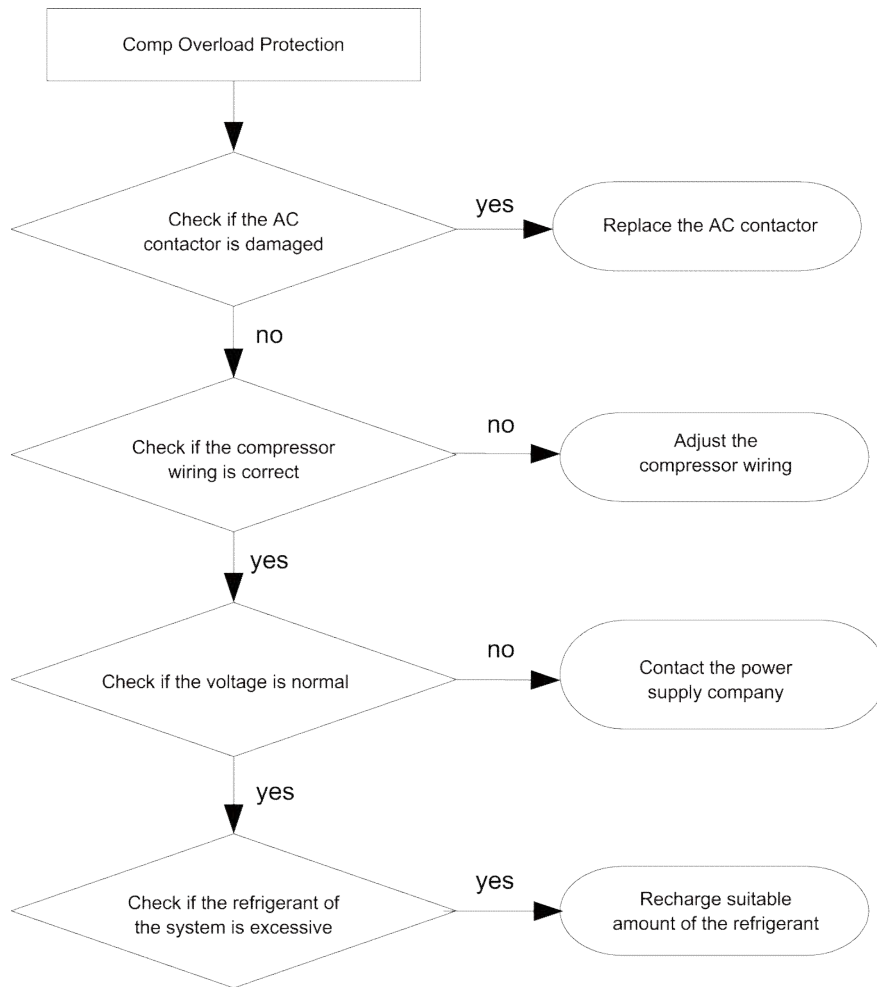

3.5 DC Fan Error EF

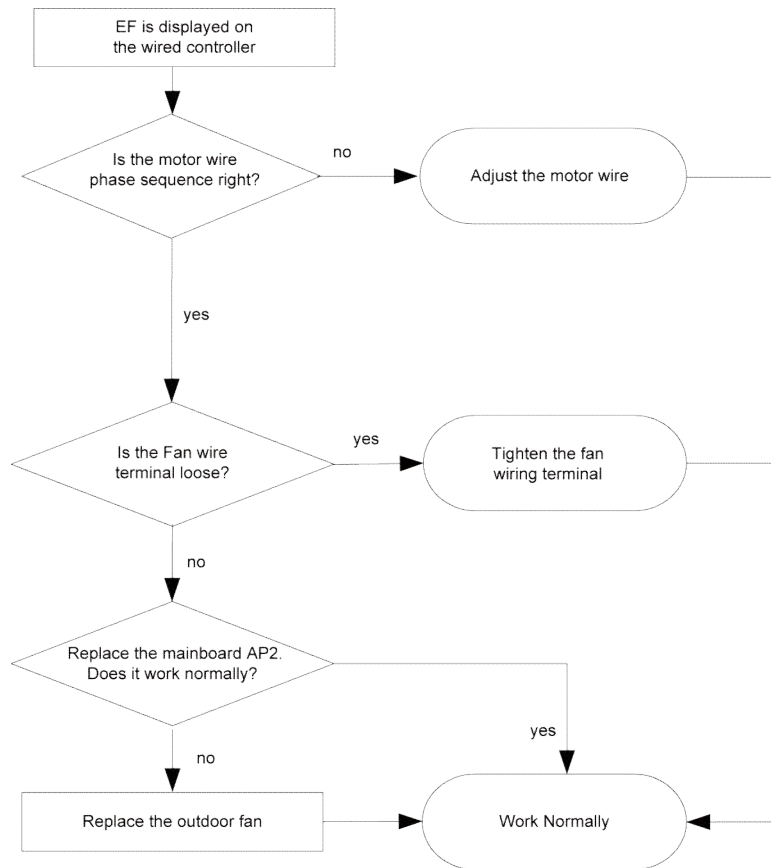

3.6 Temperature Sensor Error

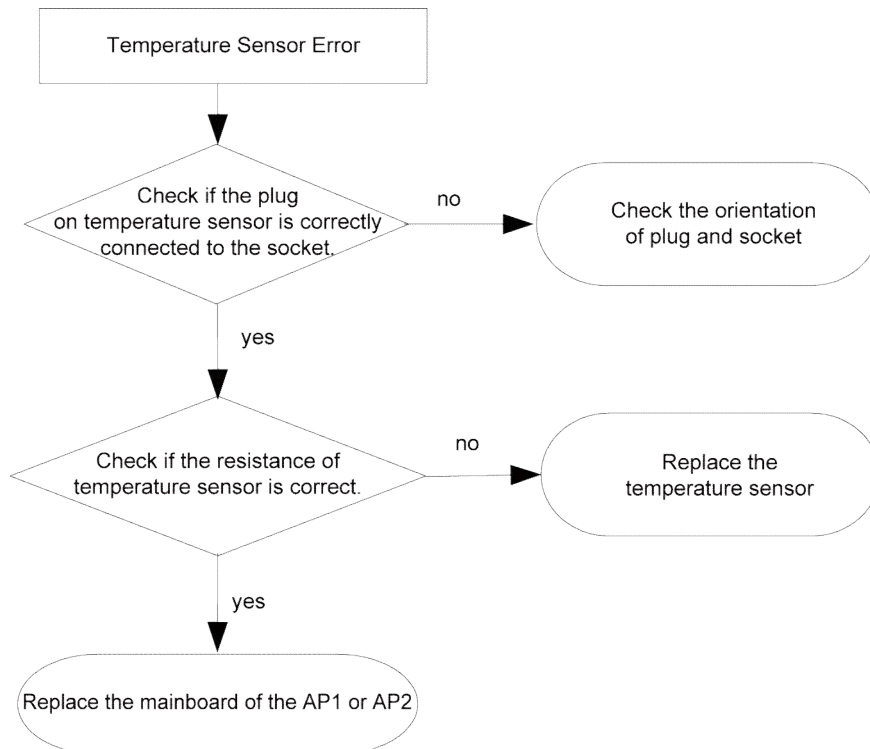

3.7 Communication Malfunction E6

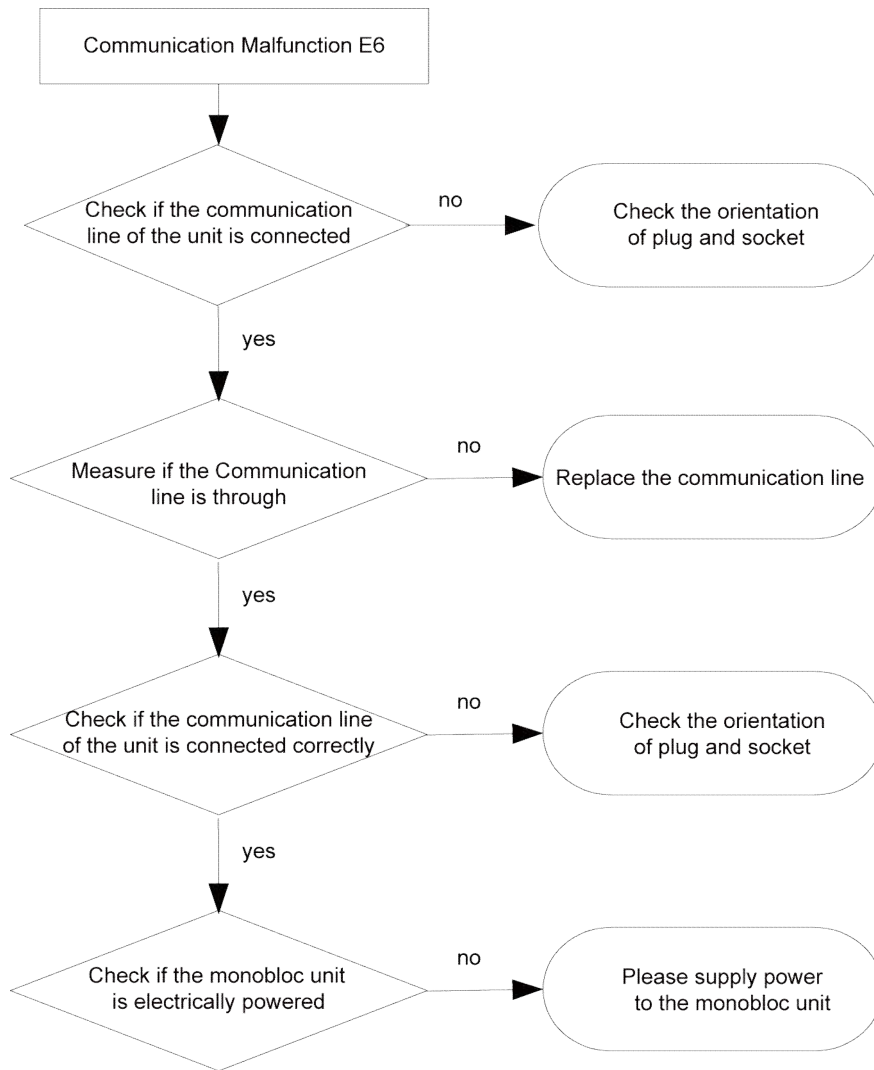

3.8 Capacity Switch Error (Code:"C5")

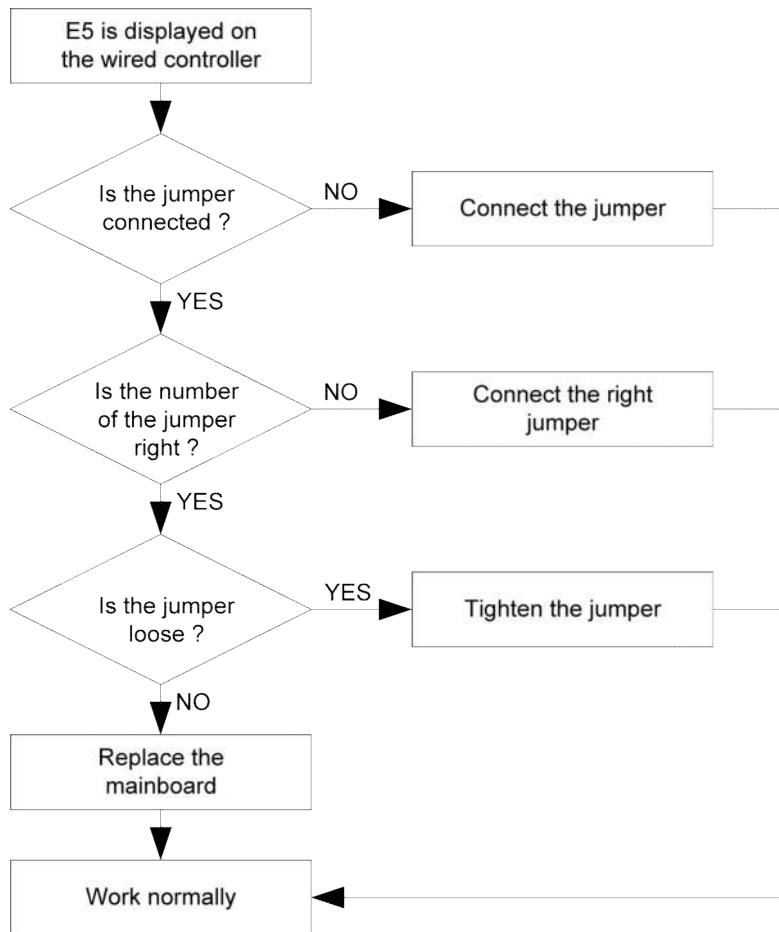

4 Diagnosis of Driving

4.1 Diagnosis Flowchart of Driving of Single-phase Unit and Three-phase

Unit

- ◆ Drive Module Reset(Code:"P0") ; IPM or PFC Temperature Sensor Error(Code:"P7") ; AC Current Protection (Input Side)(Code:"PA"); Current Sense Circuit Error(code:"PC"); PFC Protection(Code:"HC")

Test Operation & Troubleshooting & Maintenance

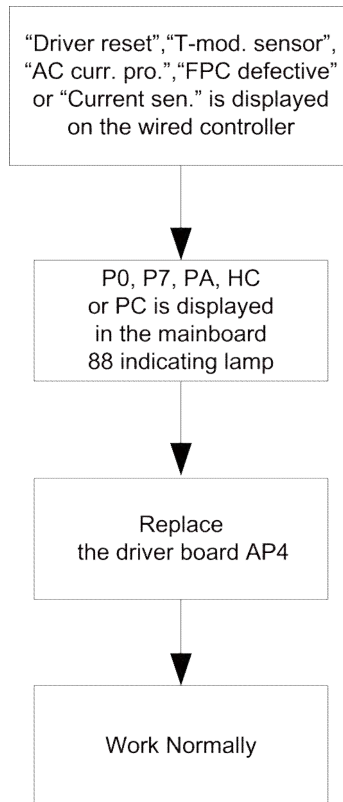

◆ IPM or PFC Over-temperature Protection(Code:"P8")

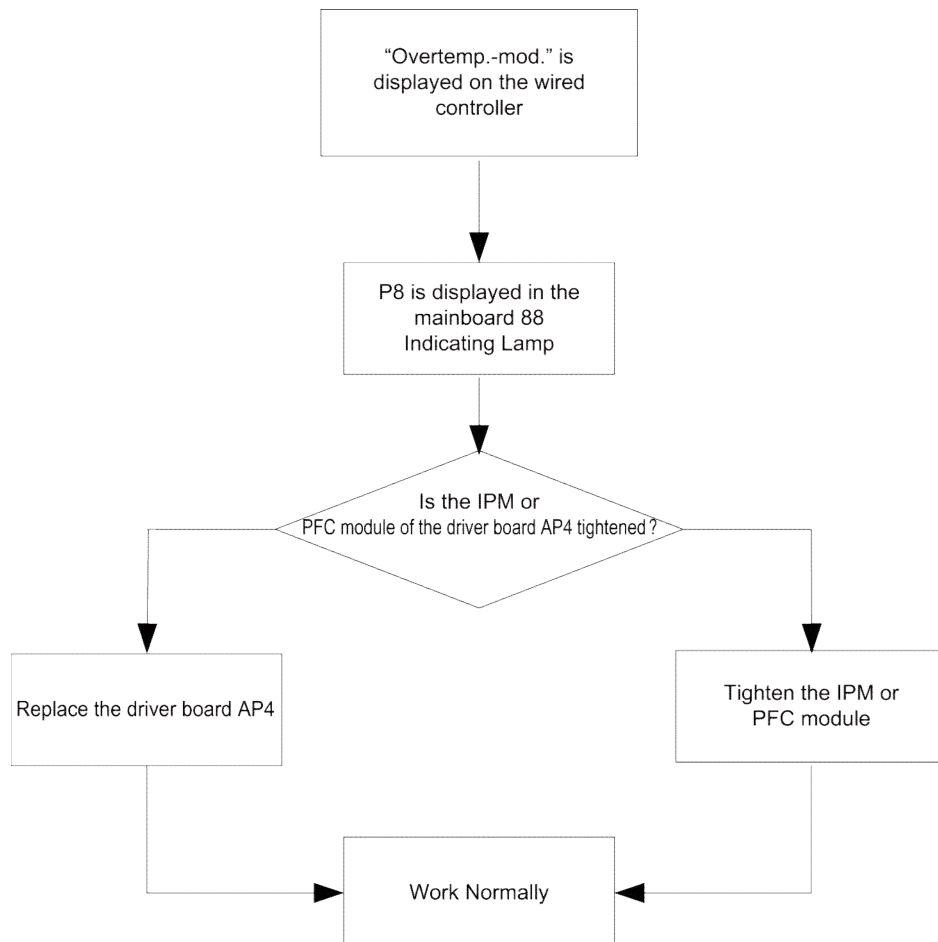

◆ DC Busbar Over-voltage Protection(Code:"PH") ; DC Busbar Under-voltage Protection (Code:"PL")

Test Operation & Troubleshooting & Maintenance

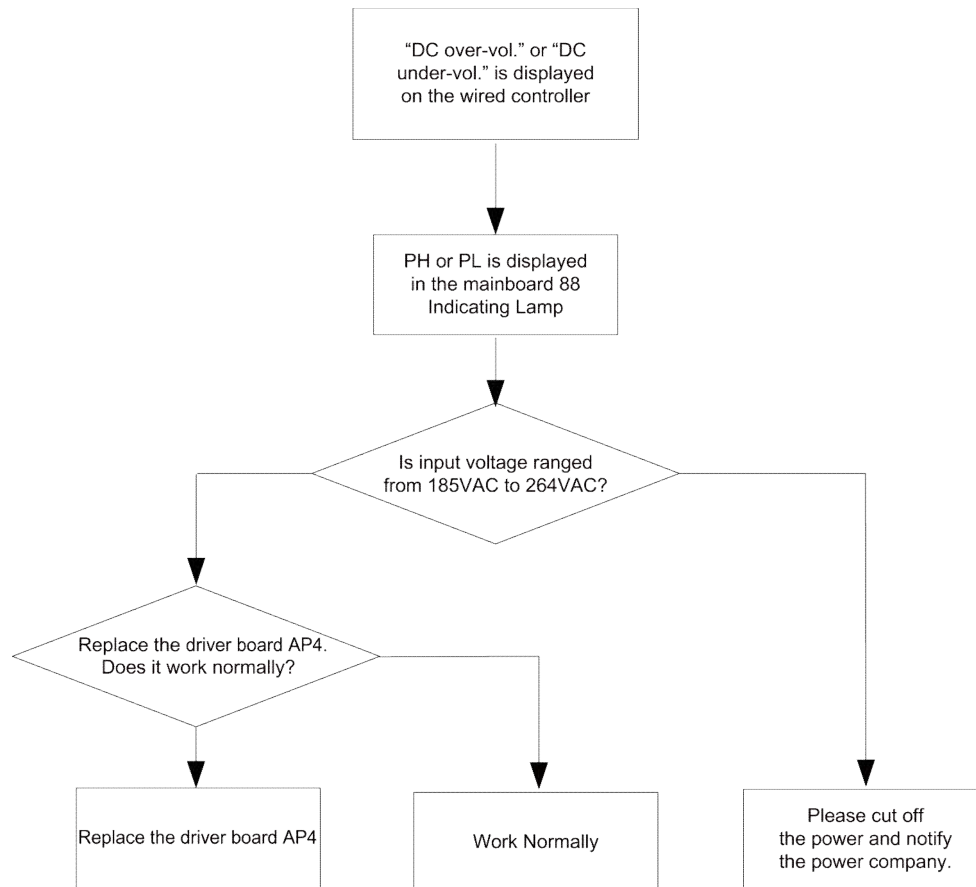

Note: three-phase input voltage is in the range from 320VAC to 475VAC.

◆ Drive-to-main-control Communication Error(Code:"P6")

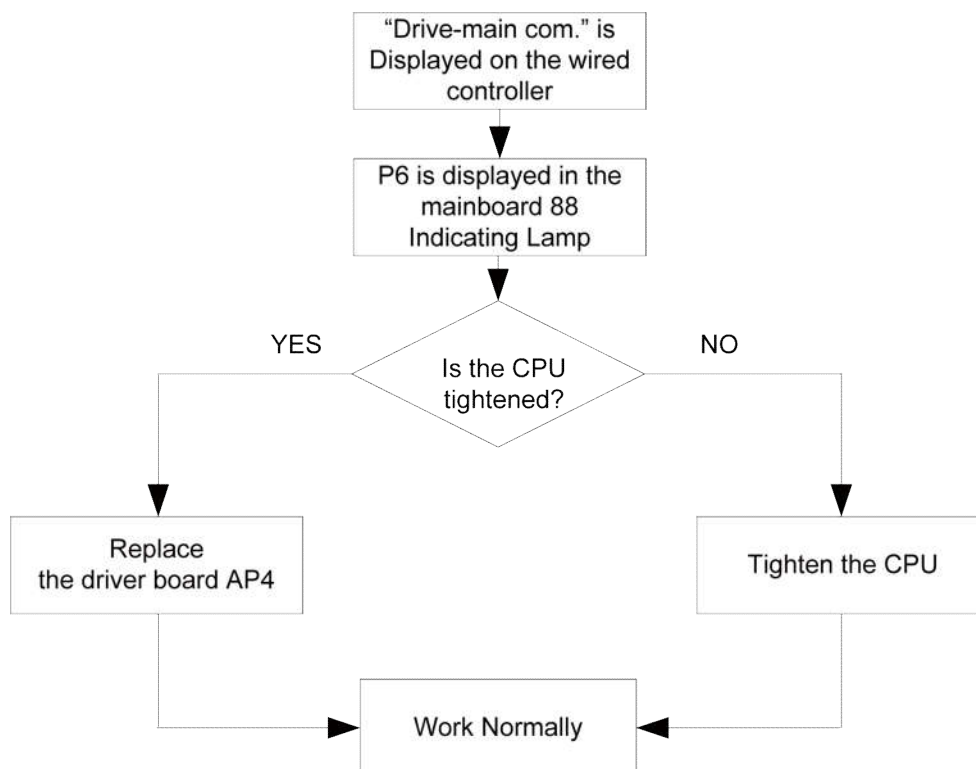

◆ Compressor Startup Failure(code:"LC")

Test Operation & Troubleshooting & Maintenance

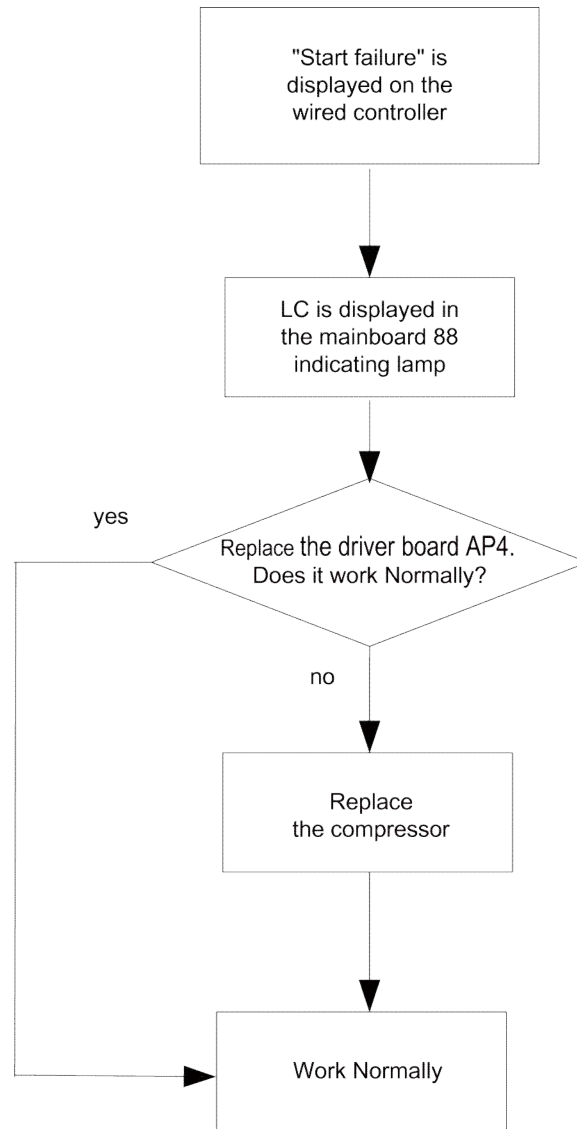

- ◆ Compressor Current Protection (Code:"P5"); Compressor Motor Desynchronizing (Code:"H7"); IPM Protection (Code:"H5"); Phase Loss (Code:"LD")

Test Operation & Troubleshooting & Maintenance

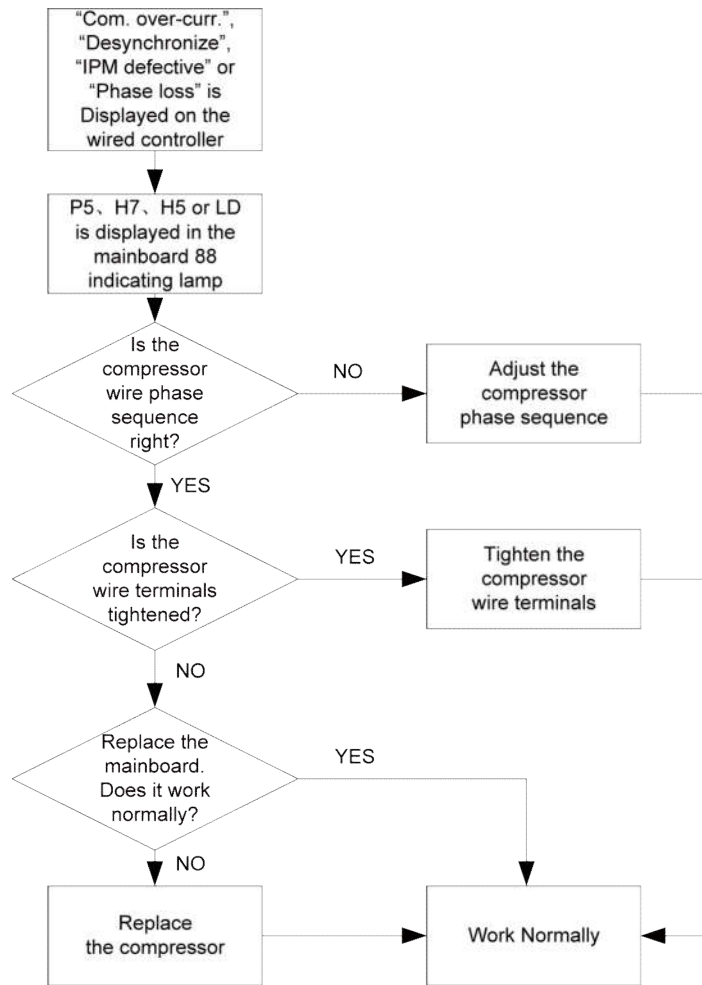

◆ Charging Circuit Error(Code:"PU")

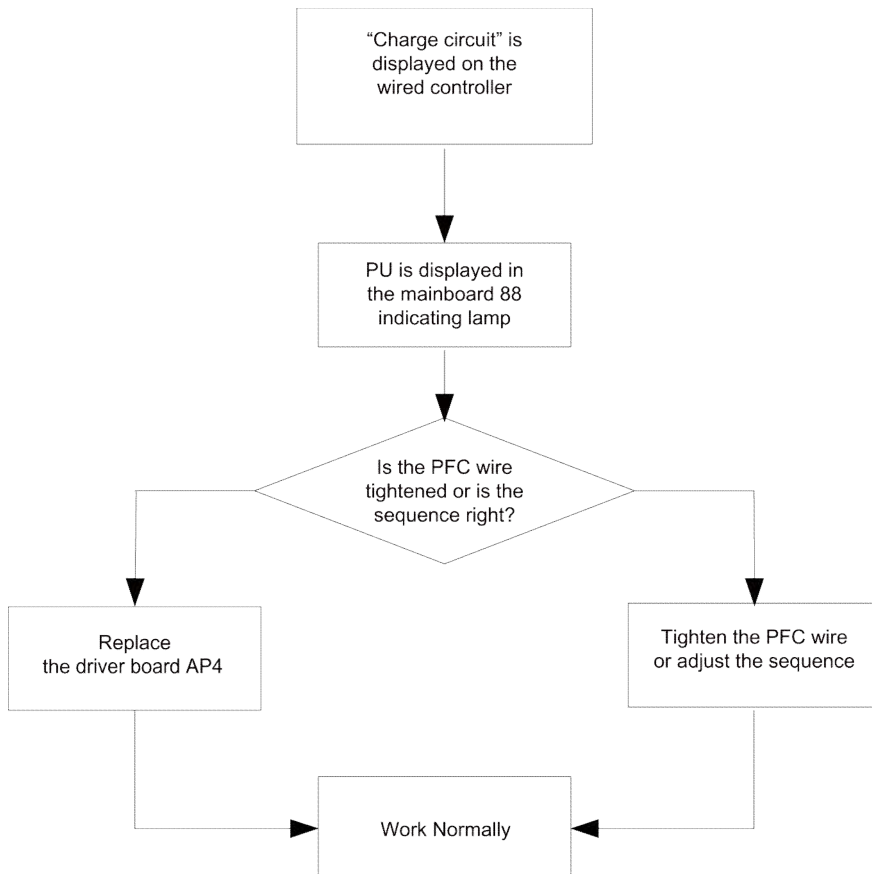

5 Daily Maintenance and Repair

5.1 Daily Maintenance

In order to avoid damage of unit, all protecting devices in the unit had been set before outgoing, so the user can never adjust or remove them.

For the first startup of the unit or next startup of unit after long-period stop (above 1 day) by cutting off the power, please electrify the unit in advance to preheat the unit for more than 8hr

Never put sundries on the unit and accessories. Keep dry, clean and ventilated around the unit.

Remove the dust accumulated on the condenser fin timely to ensure performance of unit and to avoid stop of unit for protection.

In order to avoid protection or damage of unit caused by blockage of water system, clean the filter in water system periodically and frequently check water replenishing device.

In order to ensure anti-freezing protection, never cut off the power if ambient temp. is below zero in winter.

In order to avoid frost crack of the unit, water in the unit and pipeline system not used for a long period should be drained. In addition, open the end cap of water tank for drainage.

Never frequently make the unit on/off and close manual valve of water system during operation of unit by users.

Ensure frequently check the working condition of each part to see if there is oil stain at pipeline joint and charge valve to avoid leakage of refrigerant.

If malfunction of the unit is out of control of users, please timely contact with authorized service center of company.

Note: the water pressure gage is installed in returning water line in the indoor unit, Please adjust the hydraulics system pressure according to next item:

- ① If the pressure is less than 0.5 bar, please recharge the water immediately;
- ② When recharging, the hydraulics system pressure should be not more than 2.5 Bar.

5.2 Troubleshooting

Malfuctions	Reasons	Troubleshooting
Compressor does not start up	<ul style="list-style-type: none"> ◆ Power supply has problem. ◆ Connection wire is loose. ◆ Malfunction of mainboard. ◆ Malfunction of compressor. 	<ul style="list-style-type: none"> ◆ Phase sequence is reverse. ◆ Check out and re-fix. ◆ Find out the reasons and repair. ◆ Replace compressor.
Heavy noise of fan	<ul style="list-style-type: none"> ◆ Fixing bolt of fan is loose. ◆ Fan blade touches shell or grill. ◆ Operation of fan is unreliable. 	<ul style="list-style-type: none"> ◆ Re-fix fixing bolt of fan. ◆ Find out the reasons and adjust. ◆ Replace fan.
Heavy noise of compressor	<ul style="list-style-type: none"> ◆ Liquid slugging happens when liquid refrigerant enters into compressor. ◆ Internal parts in compressor are broken. 	<ul style="list-style-type: none"> ◆ Check if expansion valve is failure and temp. sensor is loose. If that, repair it. ◆ Replace compressor.
Water pump does not run or runs abnormally	<ul style="list-style-type: none"> ◆ Malfunction of power supply or terminal. ◆ Malfunction of relay. ◆ There is air in water pipe. 	<ul style="list-style-type: none"> ◆ Find out the reasons and repair. ◆ Replace relay. ◆ Evacuate.
Compressor starts or stops frequently	<ul style="list-style-type: none"> ◆ Poor or excess refrigerant. ◆ Poor circulation of water system. ◆ Low load. 	<ul style="list-style-type: none"> ◆ Discharge or add part of refrigerant. ◆ Water system is blocked or there is air in it. Check water pump, valve and pipeline.

Test Operation & Troubleshooting & Maintenance





		<p>Clean water filter or evacuate.</p> <ul style="list-style-type: none"> ◆ Adjust the load or add accumulating devices.
The unit does not heat although compressor is running	<ul style="list-style-type: none"> ◆ Leakage of refrigerant. ◆ Malfunction of compressor. 	<ul style="list-style-type: none"> ◆ Repair by leakage detection and add refrigerant. ◆ Replace compressor.
Poor efficiency of hot water heating	<ul style="list-style-type: none"> ◆ Poor heat insulation of water system. ◆ Poor heat exchange of evaporator. ◆ Poor refrigerant of unit. ◆ Blockage of heat exchanger at water side. 	<ul style="list-style-type: none"> ◆ Enhance heat insulation efficiency of the system. ◆ Check if air in or out of unit is normal and clean evaporator of the unit. ◆ Check if refrigerant of unit leaks. ◆ Clean or replace heat exchanger.

5.3 Repair



5.3.1 Key Components

Picture	Name	Function
	Compressor	It is the heart of the cooling system, mainly used to turn the low-temperature, low-pressure refrigerant vapor to high-temperature high-pressure vapor and then discharge it to the evaporator. The two-stage enthalpy-adding compressor is adopted herein, which can improve the heating performance of the unit largely.
	Electrostatic Expansion Valve	It is one of four main components and used to turn the hi-pressure liquid refrigerant to low-temperature, low-pressure vapor-liquid mixture and adjust the refrigerant flow rate entering the evaporator.
	Vapor Liquid Separator	It is installed at the side of the suction line, and used to prevent liquid refrigerant entering the compressor, which if not avoided will lead to wet compression or even liquid slugging.

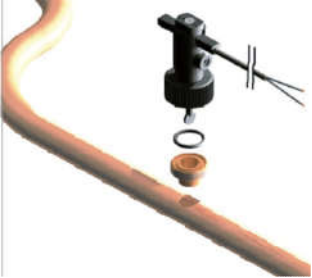
Test Operation & Troubleshooting & Maintenance

	<p style="text-align: center;">4-way Valve</p>	<p>It is used the switch flow direction of refrigerant and then realize switchover between cooling and heating. It also can be used for defrosting through the counterflow.</p>
	<p style="text-align: center;">Plate Heat Exchanger</p>	<p>It is the water-refrigerant plate type heat exchanger, used to liquefy the high-temperature high-pressure vapor refrigerant or evaporate the low-temperature low pressure liquid refrigerant. Heat of condensation is taken away by circulation water and heat for evaporation is supplied also by circulation water.</p>
	<p style="text-align: center;">Water Pump</p>	<p>It is the power equipment for water circulation.</p>
	<p style="text-align: center;">Expansion Tank</p>	<p>It is used to keep stable pressure of the water system. The tank is charged with a certain volume of nitrogen which is separated from the water side with a gasbag. When pressure of the water side exceeds the nitrogen pressure, the gasbag will expand and water enters into the tank so as to lower the pressure of the water system. In contract, when pressure of the water system goes down, nitrogen in the tank will expel water out to the water system.</p>
	<p style="text-align: center;">Flow Switch</p>	<p>It is used to prevent the heat exchanger from being frozen owing to reduced water flow rate. When the flow rate goes down to the point at which the flow switch will act, the switch will trip off and the unit will raise an alarm and shut down.</p>

Test Operation & Troubleshooting & Maintenance

	<p style="text-align: center;">Three-pipe Liquid Receiver</p>	<p>Three pipes are connected to two electrostatic expansion valves and the enthalpy-adding port of the compressor respectively. It is mainly used to further reduce pressure of the refrigerant which has gone through the first-stage throttling and then vaporize some refrigerant. The vaporized refrigerant will be sucked in the compressor again so as to enhance the heating performance of the system.</p>
	<p style="text-align: center;">Safety Valve</p>	<p>It is used to prevent the pressure of circulation water from increasing unusually. When the pressure is larger than the set point (0.6MPa), this valve will open to relieve water pressure.</p>
	<p style="text-align: center;">Exhaust Valve</p>	<p>It is used to expel air trapped inside the water system to make sure normal operation of the system. It is usually installed at the highest point of the system.</p>

5.3.2 Charging and Discharging of Refrigerant

(1) Before shipped out from manufacturer, the outdoor unit has been filled with refrigerant. Additional refrigerant may be filled when carrying out site connection of pipelines.

(2) Check the liquid valve and the gas valve of the outdoor unit. The valves shall be completely shut off.

(3) Connect a vacuum pump to the liquid valve and the gas valve of the outdoor unit to remove air from the inside of the indoor unit and the connecting pipe. Refer to the following figure:

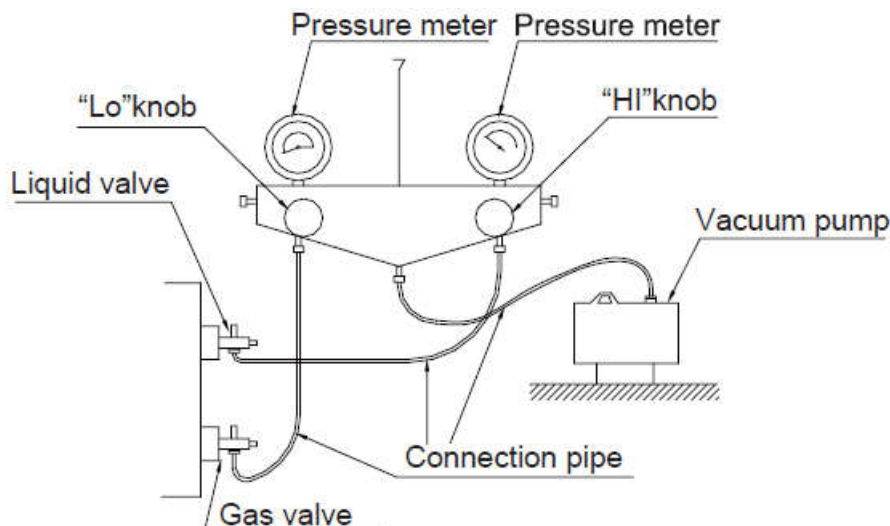

Test Operation & Troubleshooting & Maintenance

(4) After confirming that there is no leakage from the system, when the compressor is not in operation, charge additional R410A working fluid with specified amount to the unit through the filling opening of the liquid pipe valve of the outdoor unit.

- ◆ Be sure to charge the specified amount of refrigerant in liquid state to the liquid pipe. Since this refrigerant is a mixed refrigerant, adding it in gas form may cause the refrigerant composition to change, preventing normal operation.
- ◆ Before charging, check whether the refrigerant cylinder is equipped with a siphon tube or not.

