

# Burner Controller ecoMAX850P2-C

FOR BOILERS FUELLED WITH PELLETS

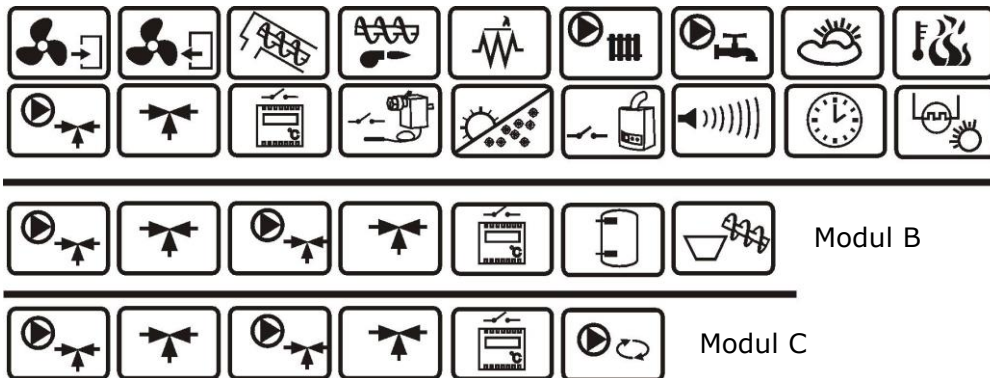

\*\*\* room panel ecoSTER200/ecoSTER TOUCH - non standard option

## USER MANUAL FOR MAINTENANCE AND INSTALLATION

EDITION: 1.0

APPLIES FOR  
HARDWARE:

MODUL A

PANEL

v02.XX.XX

v.02.XX.XX



# INDEX

1	SAFETY .... <b>CHYBA! ZÁLOŽKA NENÍ DEFINOVÁNA.</b>	
2	GENERAL INFORMATION .....	5
3	DATA REFERRING TO DOCUMENTATION .....	5
4	DOCUMENTATION STORAGE .....	5
5	SYMBOLS AND MARKINGS USED .....	5
6	WEEE 2002/96/EG ELECTRICITY AND ELECTRONICS BILL.....	5
<b>USER MANUAL OF THE CONTROLLER .....</b>		
7	USER MENU .....	8
8	SERVICE ... <b>CHYBA! ZÁLOŽKA NENÍ DEFINOVÁNA.</b>	
8.1	BUTTONS DESCRIPTION.....	9
8.2	MAIN WINDOW.....	9
8.3	CONTROLLER START UP.....	10
8.4	BOILER TEMPERATURE SETTING .....	10
8.5	FIRING UP .....	10
8.6	WORK.....	11
8.7	SUPERVISION .....	12
8.8	BURNING OFF.....	12
8.9	PAUSE.....	12
8.10	GRATE .....	13
8.11	HOT WATER SETTINGS .....	13
8.12	HOT WATER TEMPERATURE SETTINGS .....	13
8.13	HYSTERESIS OF HOT WATER FEEDER.....	13
8.14	SUMMER FUNCTION START UP .....	13
8.15	HOT WATER FEEDER DISINFECTION .....	14
8.16	MIXER CIRCLE SETTINGS.....	14
8.17	WEATHER CONTROL.....	15
8.18	NIGHT DECREASE SETTINGS DESCRIPTION....	16
8.19	CIRCULAR PUMP CONTROL .....	16
8.20	FUEL LEVEL CONFIGURATION.....	16
8.21	COOPERATION WITH ADDITIONAL FEEDER...	17
8.22	INFORMATION .....	17
8.23	MANUAL CONTROL .....	18
<b>USER MANUAL OF CONTROLLER</b>		
<b>INSTALLATION AND SERVICE SETTINGS.....</b>		
9	HYDRAULIC SCHEMES .....	23
10	TECHNICAL DATA .....	26
11	STORAGE AND TRANSPORT CONDITIONS.....	26
12	CONTROLLER INSTALLATION .....	26
12.1	ENVIRONMENTAL CONDITIONS.....	26
12.2	WYMAGANIA MONTAŻOWE .....	26
12.3	INSTALLATION .....	27
12.4	ELECTRIC CIRCUIT CONNECTION .....	27
12.5	SAFETY CONNECTIONS.....	28
12.6	ELECTRIC SCHEME .....	29
12.7	TEMPERATURE SENSORS CONNECTION.....	30
12.8	WEATHER SENSORS CONNECTION.....	30
12.9	WEATHER SENSORS CHECKING .....	30
12.10	OPTICAL SENSOR CONNECTION .....	31
12.11	MIXERS ROOM TEMPERATURE CONNECTION .....	31
12.12	BOILER ROOM THERMOSTAT CONNECTION..	31
12.13	RESERVE BOILER CONNECTION .....	31
12.14	ALARMS SIGNAL CONNECTION.....	33
12.15	MIXER CONNECTION .....	34
12.16	CIRCULAR PUMP CONNECTION .....	35
12.17	TEMPERATURE LIMITER CONNECTION .....	35
12.18	ROOM PANEL CONNECTION .....	35
13	SERVICE MENU .....	36
14	SERVICE SETTINGS .....	37
14.1	BURNER .....	37
14.2	BOILER .....	39
14.3	CH AND HW .....	40
14.4	BUFFER .....	41
14.5	MIXER .....	41
14.6	ADVANCED PARAMETERS.....	42
16	ALARMS DESCRIPTIONS.....	43
16.1	BOILER MAX. TEMP. EXCEEDING .....	43
16.2	FEEDER MAX. TEMP. EXCEEDING.....	43
16.3	BOILER TEMP. SENSOR DAMAGE .....	43
16.4	FEEDER TEMP. SENSOR DAMAGE .....	43
16.5	COMMUNICATION LOST.....	44
16.6	FIRING UP FAILED ATTEMPT .....	44
16.7	UNSUCCESSFULL ATTEMPT TO LOAD THE TANK .....	44
17	OTHER.....	44
17.1	POWER STOPPAGE .....	44
17.2	ANTIFREEZING PROTECTION .....	44
17.3	PUMP ANTI STANDSTILL FUNCTION .....	44
17.4	NETWORK FUSE REPLACEMENT .....	44
17.5	CONTROL PANEL REPLACEMENT .....	45
18	LAMBDA SENSOR $\Lambda$ .....	45
19	POSSIBLE FAULTS DESCRIPTION .....	46
20	COTROLLER CONFIGURATION BY BOILER PRODUCER.....	47
21	CHANGES REGISTER.....	47

## 1 SAFETY

Safety requirements are described in following sections of this user's manual. Apart from them please obey requirements described below.



- Before installing, mending or maintenance and during any connecting works it is absolutely necessary to disconnect the network power and to make sure if the connections and wires are not electrically powered.
- After disengaging the controller by keyboard there may still be a dangerous electrical power on its connections.
- The controller must be used in accordance with its destination.
- The controller must be covered with the box.
- Additional automatic device must be used to protect the boiler, central heating and hot water installations against the results of controller breakdown or faults in its hardware.
- It is essential to adjust parameters to the given boiler time and to the fuel type. All the conditions of usage the installation must be considered. Faults in adjusting the parameters may cause boiler emergency mode (overheating, backfire to the feeder, etc.)
- The controller is for boiler producers. The boiler producer before its use should check if the cooperation between the controller and the boiler is correct and is not dangerous.
- The controller is not a spark-safe device. It means that in emergency mode may be the source of a spark or high temperature which together with dust or flammable gases can cause fire or explosion.
- The controller must be installed by the boiler producer, in accordance with valid norms and regulations.
- Modification of programmed parameters should only be carried by a person acquainted with this user's manual.
- The controller can only be used in heating installations made in accordance with valid norms and regulations.
- The electrical circuit in which the controller works should be protected with a fuse proper for voltage used.
- The controller can not be used with damaged cover box
- On no condition can any alterations to the controller's construction be made
- The controller is equipped with an electronic disconnecter of connected devices (working type 2Y in accordance to PN-EN 60730-1) and microdisconnecter (working type 2B in accordance to PN-EN 60730-1).
- Children should not be allowed access to the controller.

## 2 GENERAL INFORMATION

The controller is a modern electronic device designed to handling the work of the pellet boiler using help of optical flame brightness sensor. The device is compactly build, easy to install.

It can control the work of central heating and hot water circuits and also control the work of 5 mixing heating circuits. The required temperature of heating circuits can be set on the basis of data obtained from the main sensor. The possibility of cooperation with room thermostats, separate for each heating circuit is beneficial for maintaining comfortable temperature in heating rooms. Moreover, the device turns on the spare boiler (gas or oil one).

The controller can cooperate with additional steering panel located in living rooms and additional modul of lambda  $\lambda$  sensor. Handling of the controller is easy and intuitive. The controller can be used within the household and in small industrial buildings.

## 3 DATA REFERRING TO DOCUMENTATION

The user's manual of the controller is a complementation of boiler documentation. In particular it is necessary to apply the boiler documentation. The user's manual of the controller is divided into two parts: for the user and for the installer. However in both parts vital information concerning safety is included. That is why the user should get acquainted with both parts of the user's manual.

We do not take responsibility for damages caused by failing to observe the following user manual.

## 4 DOCUMENTATION STORAGE

We advise you to keep carefully this user manual of installation and maintenance and all other valid documentation, for immediate use when needed. In case of removal or selling the device all the documentation should be handed to new user or owner.

## 5 SYMBOLS AND MARKINGS USED

Following graphic symbols and markings are used in the user manual:



- for relevant information and tips,



-for vital information related with issues of property damage, health and life risk of humans or domestic animals,

Attention: by these symbols vital information is marked. It is to allow easy understanding of the user manual. User and installer is however required to observe recommendations not expressed by graphic symbols!

## 6 WEEE 2002/96/EG ELECTRICITY AND ELECTRONICS BILL



- The packaging and product is to be utilised at the end of using period by a proper recycling company.
- The product can not be disposed together with ordinary wastes.
- The product can not be burned.



USER MANUAL OF THE CONTROLLER

# ecoMAX850P2-C

---

## 7 USER MENU

Main menu
Information
Boiler settings
HUW settings *
Mixer 1 settings 1-5*
Night time decrease
Summer/Winter
General settings
Manual control
Alarms
Service settings

Boiler settings
Preset boiler temperature
Weather control boiler *
Heating curve *
Curve shift *
Room temperature factor *
Output modulation
<ul style="list-style-type: none"> <li>Max Boiler output</li> <li>Max Blow-in output</li> <li>Max Oxygen*</li> <li>MED H2 Hysteresis</li> <li>MED Boiler output</li> <li>MED Blow-in output</li> <li>MED Oxygen*</li> <li>MIN H2 Hysteresis</li> <li>MIN Boiler output</li> <li>MIN Blow-in output</li> <li>MIN Oxygen*</li> <li>Boiler hysteresis HK</li> <li>Min boiler output FL</li> <li>Max boiler output FL</li> <li>Feeder efficiency</li> <li>Feeder test</li> <li>Fuel mass in the test</li> <li>Blow-in grate mode *</li> </ul>
Boiler oper. mode *
<ul style="list-style-type: none"> <li>Pellet</li> <li>Grate</li> </ul>
Regulation mode
<ul style="list-style-type: none"> <li>Standard</li> <li>Fuzzy Logic</li> <li>Lambda Fuzzy Logic</li> </ul>
Fuel type
Fuel level
Burner cleaning
Cleaning intensity

HUW settings *
Preset HUW temperature
HUW pump mode
<ul style="list-style-type: none"> <li>Off</li> </ul>

<ul style="list-style-type: none"> <li>Priority</li> <li>No priority</li> </ul>
HUW cont. hysteresis
HUW disinfection

Sommer/Winter
SUMMER mode
<ul style="list-style-type: none"> <li>Summer</li> <li>Winter</li> <li>Auto</li> </ul>
Activ. temperature SUMMER
Deactv.temperature SUMMER

Mixer settings 1,2,3,4,5*
Preset mixer temperature
Mixer room thermostat
Weather control mixer *
Heating curve Mixer *
Curve shift *
Room temperature factor *

Night time decrease
Boiler
Mixer 1-5*
HUW container *
Circulation pump *

General settings
Clock
Screen brightness
Screen contrast
Sound
Language

Fuel level
Alarm level
Fuel level calibration

\* Not available if proper sensor or additional module not connected or the parameter is hidden.



## 8 Service

### 8.1 BUTTONS DESCRIPTION

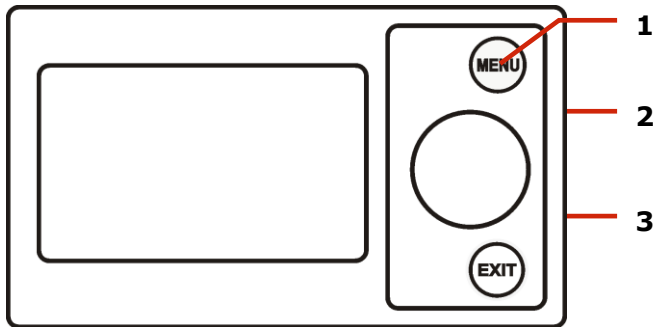

1. MENU entry button
2. „TOUCH and PLAY“ knob
3. EXIT button

„TOUCH and PLAY“ turning cause increase or decrease of edited parameter. It is a part of fast handling of the controller. Pressing the knob causes enter edition mode of chosen parameter or selecting its volume.

Pressing EXIT button causes exit selected menu level and also exit selected volume of a parameter.

### 8.2 MAIN WINDOW

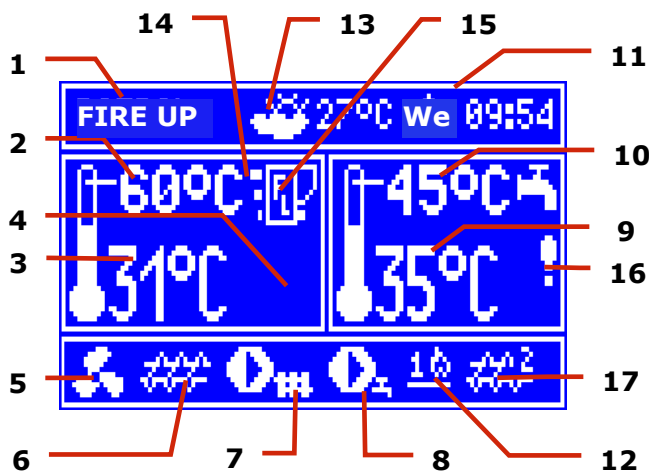

1. Controller's working modes: FIRE UP, OPERATION, SUPERVISION, BURNING OFF, BURNING OFF ON DEMAND, STOP,
2. Boiler preset temperature,
3. Boiler measured temperature,
4. Functions having influence on preset boiler temperature. Following symbols signal respectively:
  - „T“ Preset boiler temperature decrease due to thermostat disconnection;
  - „S“ Preset boiler temperature decrease due to activated time spans;

- „C“ Boiler preset temperature during loading the hot water boiler (HW);
- „M“ Boiler preset temperature increase from mixer circulation;
- „P“ weather control switch on for boiler circulation,
- „R“ active return protection,
- „B“ Preset temperature increase to load the buffer.

5. Symbol signalling blowing operation,
6. Symbol signalling fuel feeder operation,
7. Symbol signalling central heating (CH) pump operation,
8. Symbol signalling central heating pump operation (HW),
9. Measured temperature of hot water boiler (HW),
10. Preset hot water (HW) boiler temperature,
11. Clock and weekday
12. Part of the screen coshared between two icons: match – symbolizes operating heater, and the digit next to it stands for a number of Firing-upattempts; Rake – symbolizes activating automatics of furnace cleaning,
13. External (weather) temperature,
14. Current boiler power level,
15. Symbol signalling activating regulating mode *IndividualFuzzyLogic*,
16. Symbol signalling disinfection of the hot water boiler<sup>1</sup>
17. Additional feeder (connected to module B).

Right window on the main screen is configurable, allows on changing information displayed there. It is possible to choose a configuration displaying: mixer circuit (1, 2, 3, 4, 5), info or HW by twisting the “TOUCH and PLAY” knob.

Right window on the main screen may also display the fuel level view, providing that this parameter is set correctly. Details are shown in point 8.20.

<sup>1</sup> Symbol is displayed not only during active HW decontamination function, but appears also during active HW disinfection function.

Attention: fuel level can be seen in room panel ecoSTER200.

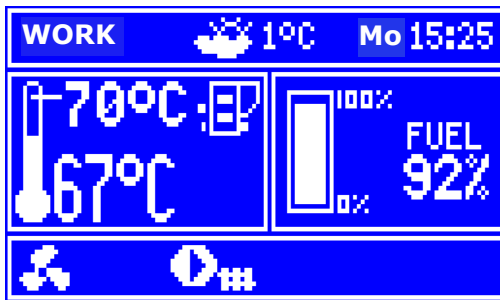

### 8.3 CONTROLLER START UP

After connecting the power the controller shows the settings put before connecting the electricity. If the controller has not operated before – it will start up in „stand by” mode. In this mode the screen is dimmed, actual time and information: *Boiler on* is displayed.

In this mode protecting pumps against going stale function is in operation. It is executed by temporary switching them on. Therefore it is advised to keep the electrical power to the controller on when the boiler is not in use. And the controller should be in “stand by” mode. It is possible to start up the boiler (pressing the encoder knob and selecting „switch on”) or setting parameters of its operation (MENU button) without connecting it to the electrical power. After making sure that fuel is in the silo, and the hatch is closed – the boiler can be switched on.

### 8.4 BOILER TEMPERATURE SETTING

The preset boiler temperature and preset circuits temperature can be set in the menu (Possible temperatures are restricted with range of respective service parameters of the controller).

**Menu→Boiler settings → Preset boiler temperature.**

**Menu→Mixer settings 1-5 → Preset mixer temperature**

The parameter value: *Preset boiler temperature*, is by controller bypassed when the preset boiler temperature is controlled by weather sensor. Regardless of that, the preset boiler temp. is automatically increased to load the hot user water tank and power heating circuits of mixers.

## 8.5 FIRING UP

FIRING UP mode is for automatic firing up of furnace in boiler. Total time of firing up proces is dependand on controller’s settings (feeder operation time, heater operation time, etc.) and on boiler’s condition before firing up. Parameters influencing firing up process are in the menu:

**Menu → Service settings → Boiler settings → Firing up**

In case of failed attempt of firing up the furnace, another attempts are taken during which amount of fuel (feeding time) is reduced to 10% of first attempt’s dose.

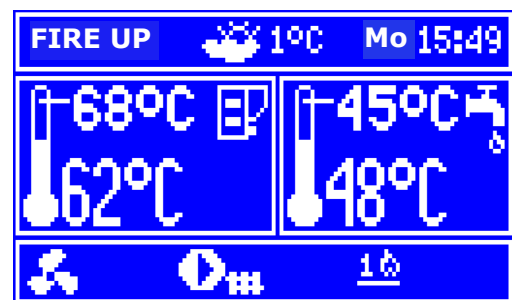

After three failed firing up attempts an alarm Failed firing up attempt is reported. Boiler’s operation is then stopped. It is not possible to automatically continue boiler’s operation. Service intervention is required. After finding and solving the cause of firing up failure the boiler should be fired up again.

## 8.6 WORK

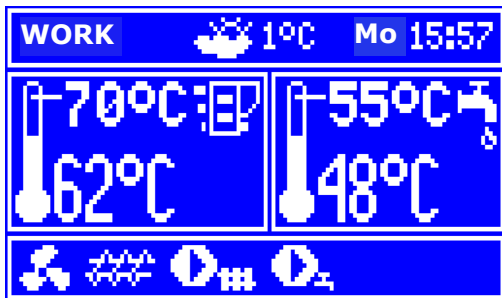

The fan operates constantly. Fuel feeder is engaged periodically. One period consists of feeder operating time and pause in feeding time:

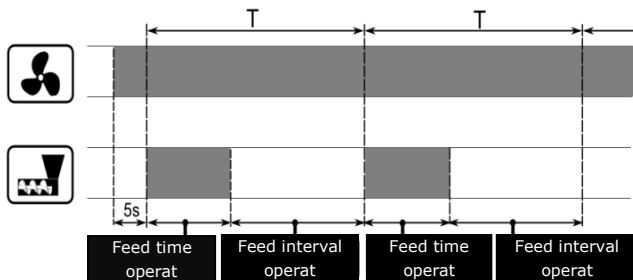

Cycle time operation parameter is located in: **Menu** → **Service Settings** → **Burner settings**.

Feeder operation time is calculated automatically depending on the required current power of the burner, feed efficiency and calorific value of the fuel.

Parameters of airflow output for different power levels of the burner are available in:

**Menu** → **Boiler settings** → **Output modulation**

You can choose between two adjustment modes responsible for stabilizing the boiler preset temperature Standard and Fuzzy Logic. This mode changes in:

**Menu** → **Boiler settings** → **Regulation mode**

- **Standard mode operation**

If the boiler's temperature reach preset one then the controller switches of to SUPERVISION mode.

Controller is equipped with boiler's power modulation mechanism – which allows for gradual power reduction when approaching the preset temperature.

There are three power levels:

MAX/MED/MIN power

Current power level is displayed on the screen as 3 segmented indicator at the left side of boiler's icon.

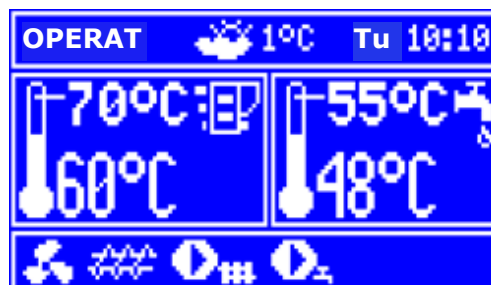

Each level can be allocated with separate fuel feeding times and Air flush intensity which influence on actual boiler's power level. Power levels parameters are available in the menu:

**Menu** → **Boiler settings** → **Output modulation**

The controller regulates burner's power with which it operates depending on preset temperature and defined hysteresis *Hysteresis H2* and *Hysteresis H1*.

It is possible to configure volumes H1 and H2 in such a way that modulation is done without intermediate position. That means switching from MAX to MIN with omission of MED power.

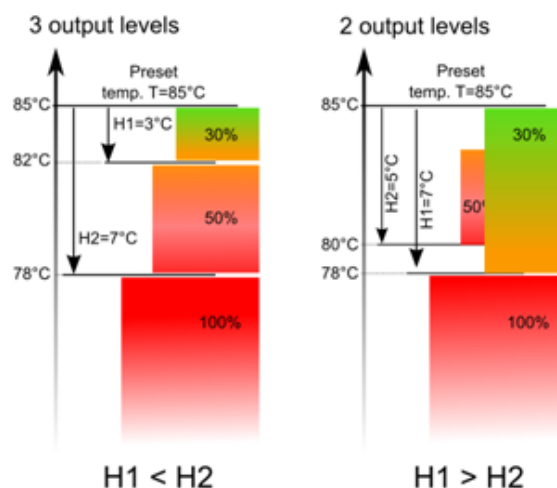

- **Operation in Fuzzy Logic mode**

In Fuzzy Logic mode the controller automatically regulates burner power to allow boiler operation in such a way to maintain its temperature on preset level. The controller uses power levels defined in Standard mode. In this mode the parameters *Hysteresis H2* and *Hysteresis H1* do not have to be set.

The Fuzzy Logic mode unlike the Standard mode is not faulty in respect of failing to reach the preset boiler temperature due to incorrect adjustment of *Hysteresis H2* and *Hysteresis H*. It also allows for quicker reach the preset temperature. In addition, you can adjust the boiler output in FL mode by the parameters Min / Max power boiler FL.

 Attention: If the boiler operates without heat buffer and controller is switched into SUMMER mode than Standard mode operation of the controller is recommended.

After exceeding the preset temperature by 5 degrees C the controller switches into SUPERVISION mode.

## 8.7 SUPERVISION

SUPERVISION mode is applicable either in regulation in STANDARD and Fuzzy Logic mode.

The controller switches into SUPERVISION mode automatically without user's intervention:

- in Standard regulation mode – after reaching the boiler preset temperature,
- in Fuzzy Logic steering – after exceeding boiler preset temperature by 5 degrees C.

In SUPERVISION mode the controller oversees the furnace, keeping it from burning off. To do so, the burner operates with very low power, what together with properly adjusted parameters do not cause further increase in temperature. Burner's power in SUPERVISION mode and other parameters of Supervision are grouped in menu:

**Menu → Service settings → Boiler settings → Supervision**

Parameters of SUPERVISION mode are to be set in accordance to burner/boiler producer's recommendations. They should be so chosen to prevent the furnace from burning off during boiler's pauses (the furnace should not at the same fire up to too high a temperature, because it will cause too high a temperature of the boiler). Operation and pause time of the feeder in SUPERVISION mode is set using following parameters:

*Feeding time SUPERVISION*, *Period time SUPERVISION* and *Air flush intensity SUPERVISION*.



The parameters in this mode must be so chosen as to make the boiler temperature gradually decreasing. Incorrect settings can cause boiler overheating.

Maximum time of boiler's operating in supervision mode is defined in parameter *Supervision time*. If after this time (in Supervision mode) there is no need to restart the boiler then the controller starts the process of boiler's burning off.

 For setting *Supervision time* = 0 the controller omits SUPERVISION mode and goes directly to BURNING OFF.

## 8.8 BURNING OFF

In burning off mode the leftovers of pellet are burnt and the boiler is prepared to pause or deactivation.

All the parameters influencing burning off process are grouped in menu:

**Service settings → Boiler settings → Burning off**

The controller stops feeding fuel and makes periodical blowings to burn off remnants of fuel. After decrease of flame brightness or maximum time of burning off expiration the controller turns into PAUSE mode.

## 8.9 PAUSE

In PAUSE mode the boiler is being burnt off and awaits the signal to start operation. The following can be a signal to start operation:

- Decrease of preset boiler temperature below preset temperature diminished by boiler hysteresis (*Boiler hysteresis*),
- By boiler operation configuration with the buffer decrease of top buffer temperature below preset value (*Buffer loading start temperature*).

### 8.10 GRATE

Some boilers have an additional grate to burn other fuels such as wood waste, etc. To activate the grid, move the parameters available in the:

**Main menu → Boiler settings → Boiler oper. mode**

from "pellet" to "grid". In the grid mode fuel feeder is turned off. The combustion process is regulated by the fan. Fan power, when working with grid, is set in:

**Boiler settings → Output modulation → Blow-in output – grate**

The values of parameters such as:

**Boiler settings → Preset boiler temperature**

**Boiler settings → Output modulation → Boiler hysteresis**

**Service Settings → Burner settings → Fuel detection time**

are individually adjusted for the "grate". This allows you to define different properties of boiler operation for operation modes "grate" and "pellets".

When using the grid an alarm "No fuel" can appear. This alarm occurs when a temperature drops below the value of the parameter:

**Menu → Service settings → CH and HUW settings → CH activation temp.** and then for a period of 10 minutes there has been no growth.

### 8.11 HOT WATER SETTINGS

The controller regulates temperature of the silo of Hot Water HW, providing that the temperature sensor is connected. When the

sensor is disconnected – the information about it is displayed in the main window. By selecting: **Menu → HUW settings → HUW Pump mode** the user is able to:

- deactivate feeding the silo, parameter *Deactivated*,
- setting HUW priority, by parameter *Priority* – then CH pump is deactivated to feed the HUW boiler quicker,
- set simultaneous operation of CH and HUW pump with the parameter *No priority*,
- Activate function *Summer*.

### 8.12 HOT WATER TEMPERATURE SETTINGS

Preset temperature HUW is defined by parameter:

**Menu → HUW settings → Preset HUW temperature**

### 8.13 HYSTERESIS OF HOT WATER FEEDER

Below temperature *Preset temperature HUW – Silo hysteresis HUW* the HUW pump will activate to feed the HUW silo.



By small hysteresis value HUW pump will activate faster after HUW temperature decrease.

### 8.14 SUMMER FUNCTION START UP

To activate SUMMER function which allows feeding the silo during summer, without necessity to activate CH installation and mixers periods, it is required to set the:

**Menu → Summer/Winter → SUMMER mode for Summer .**



Attention: when boiler operates without heating buffer and the controller is switched into SUMMER mode, than Standard mode operation is recommended. point 8.6



It is not allowed to activate function summer when HW pump is disconnected or damaged.

Function SUMMER can be activated automatically, on the basis of readings from

weather sensor. Use following parameters to activate this function:

**Menu** → **Summer/Winter** → **SUMMER Mode** → **Auto**

If the automatic detection of summer mode is switched on, you can set the parameters: Start temperature summer mode, so outdoor temp. above which the summer mode will be switched on and outdoor temp. below which the SUMMER mode will be switched off. The parameters are grouped in **Menu** → **Summer / Winter**.

### 8.15 HOT WATER FEEDER DISINFECTION

The controller can automatically, periodically make HW silo warm up to 70 degrees C. It is done to remove bacterial flora.



It is absolutely important to inform all the inmates about activating the disinfection function. There is a danger of scalding with HW hot water.

Once a week at night between Sunday and Monday at 2 a.m. the controller increases temperature of HW silo. After 10 minutes of keeping the silo at 70 degrees C the HW pump is deactivated and the silo returns to its normal operation. It is not advisable to activate disinfection function while the service of HW is deactivated.

### 8.16 MIXER CIRCLE SETTINGS

Settings of first mixer circle are in the menu:

**Menu** → **Mixer 1 settings**

Settings for other mixers are in following sections of the menu and are identical in each cycle.

- **Mixer settings without weather sensor**

It is required to set manually desired temperature in mixer's heating cycle using parameter *Preset mixer temperature*, e.g. 50 degrees C. Such should be a value to provide required room temperature.

After connecting a room thermostat, value of decline in preset mixer temperature from

thermostat should be set. (parameters *mixer room thermostat* e.g. 5 degrees C. This value should be chosen experimentally. A room thermostat can be a traditional one or a room panel ecoSTER200. After activating the thermostat, mixer preset temperature will be reduced. When this value is reduced correctly then room temperature increase will be stopped.

- **Mixer with weather sensor setting**

Set parameter *mixer weather control* in position on. Adjust weather curve according to point 8.17

Using parameter *parallel curve movement* set required room temperature according to formula:

Required room temperature = 20°C + heating curve parallel movement.

Example:

To reach room temperature 25°C value of heating curve movement must be set for 5°C. To reach room temperature 18°C value of heating curve parallel movement must be set for -2°C.

In this configuration a thermostat can be connected. It will level inaccuracy of heating curve adjustment in case when its value will be too big. In such case value of decrease of preset mixer room temperature from thermostat should be set i.e. for 2°C. After disconnecting thermostat plugs preset mixer cycle temperature will be reduced. By correct adjustment of this reduction will stop temperature increase of temperature in heated room.

- **Mixer with weather sensor and room panel settings**

Set parameter *Mixer weather control*. In position off.

Adjust weather curve according to point 8.17

Controller ecoSTER200 automatically moves the heating curve depending on preset room temperature. The controller relates adjustments to 20 degrees C, i.e. for preset room temperature = 22 degrees C the

controller will move heating curve by 2 degrees C, for preset room temperature = 18 degrees C the controller will move heating curve by -2 degrees C. In some cases described in point 8.17 it can be necessary to adjust heating curve movement.

In this configuration room thermostat ecoSTER is able to:

reduce temperature of heating cycle by a constant value, when preset temperature in a room will be reached. Similarly like it was described in previous point (not recommended), or

automatically, constantly correct heating cycle temperature.

It is not recommended to use both these possibilities at the same time.

Automatic correction of room temperature is done according to formula:

Correction = (preset room temperature - measured room temperature) x room temperature factor / 10

Example.

Preset temperature in heating room (set in ecoSTER200) = 22 degrees C. Measured temperature in room (using ecoSTER200) = 20 degrees C. *room temperature factor* = 15  
 Preset mixer temperature will be increased by  $(22 \text{ degrees C} - 20 \text{ degrees C}) \times 15/10 = 3 \text{ degrees C}$ . Correct value of parameter must be found room temperature factor. Scope: 0...50. The bigger value of factor the bigger correction of preset boiler temperature factor. When set on value "0" preset mixer temperature is not corrected. Attention: setting too high value of room temperature factor may cause cyclic room temperature fluctuations.

### 8.17 WEATHER CONTROL

Depending on measured outside temperature, automatically controlled can be either preset boiler temperature and mixer cycles temperatures. By correct adjustment

of heating curve temperature of heating circuits is counted automatically depending on value of external temperature. Thanks to that by choosing proper heating curve for given building, room temperature remains approximately the same - no matter what outside temperature.

**Attention:** in the proces of experimental ajustement of proper heating curve it is necessary to exlude influence of room thermostat on controller work (irrespective if room thermostat is connected or not), by adjusting parameter:

- for mixer cycle: **Mixer settings 1 - Mixer room thermostrat = 0**

In case of connected room panel set additionally *room temperature factor* = 0

Guidelines for correct heating curve settings:

- Floor heating 0,2 - 0,6
- Radiator heating 1,0 - 1,6
- Buffer 1,8 - 4

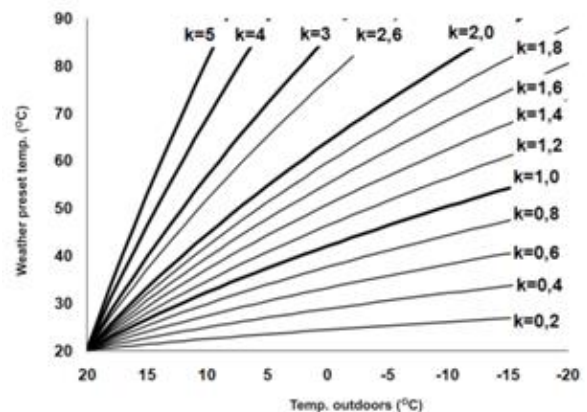

Tips for choosing proper heating curve:

- If by falling outer temperature room temperature is increasing, then value of chosen heating curve is too big,
- If by decreasing outer temperature, room temperature is also decreasing, then value of chosen heating curve is too low,
- by frosty weather room temperature is appropriate and in warmer time is too low - it is recommended to increase parameter *heating curve parallel shift* and then choose lower heating curve

- If by frosty weather room temperature is too low and in warmer time too high – it is recommended to reduce *parameter heating curve parallel shift* and choose higher heating curve.

Buildings which are poorly isolated require setting heating curve with higher values, and for better isolated buildings heating curve will have lower value.

Preset temperature, counted according to heating curve can be decreased or increased by controller when it goes beyond scope of limits of temperatures for given cycle.

### 8.18 NIGHT DECREASE SETTINGS DESCRIPTION

In the controller it is possible to set time periods of silo temperature reduction, heating cycles, hot water silo, and circular pump.

Time periods allow setting temperature reduction in given time period – i.e. at night or when user leaves the heated room. Thanks to it preset temperature can be reduced automatically, without loss of heating comfort by reducing fuel consumption.

This is indicated by the symbol „S”. Select the reduction of preset temperature and the beginning and end of a given period of time.

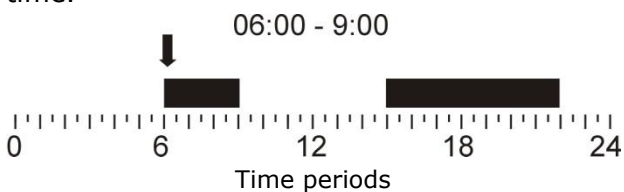

Above are examples of night-time decrease the preset boiler temperature lasting from 22:00 till 06:00 and the reduction from 09:00 to 15:00.



Attention, defining time periods during one day must be started at 00:00!



Time period is omitted by setting period reduction for value "0" even

if scope of hours is set in it

### 8.19 CIRCULAR PUMP CONTROL

Attention: functionality of circular pump is available only after connecting additional module C.

Settings are in:

**MENU → Night time decrease →Circular pump.**

oraz

**Menu → Service settings → CH and HUW settings**

Settings of time control of circular pump are analogical to settings of night reductions. In defined time periods circular pump is deactivated. In omitted periods the circular pump is switched into position *circular operation time*

Detailed settings are shown in point 14.3.

### 8.20 FUEL LEVEL CONFIGURATION

- **Fuel level indicator activating**

To activate displaying fuel level following parameters are to be set

**Menu – Boiler setting – Fuel level – Alarm level**

On value bigger than "0", i.e. 10%

Twisting "TOUCH and PLAY" knob in main window fuel level is displayed in main window.

Tip: fuel level can also be seen in room panel.



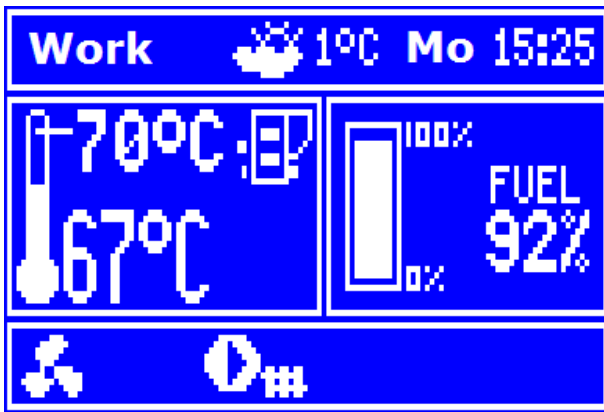

- **Fuel level indicator service**

Each time when fuel silo is filled to required level it is necessary to press and keep the knob in main window. Following info will appear:



After choosing and accepting „YES“ fuel level will be set for 100%.

Fuel can be refilled anytime, that means it is not needed to wait till the silo is empty. However fuel should be filled up to the level corresponding to 100% and set the controller level by pressing knob.

- **Description of activity**

The controller measured fuel level on the basis of its current consumption. Factory settings will not always correspond to actual fuel consumption , so to work correctly this method needs level calibration by controller’s user. No additional fuel sensors are required.

- **Calibration**

Fill the silo to the level which corresponds to full level of fuel, then set value of parameter:

## Menu – Boiler settings – Fuel level – Fuel level calibration – Fuel level 100%

In main window the indicator will be set on 100%. The calibration process is marked with a pulsating fuel level indicator. The indicator will pulsate until programming point referring to minimum fuel level. Decreasing level of fuel in the silo should be monitored constantly. When fuel level reaches expected minimum, parameter value should be set this way:

### Menu → Boiler settings → Fuel level → Fuel level calibration → Fuel level 0%

## 8.21 COOPERATION WITH ADDITIONAL FEEDER

After connecting additional B module the controller can cooperate with low fuel level sensor in silo. After activating sensor , for *auxiliary feeder operation time* controller will connect auxiliary feeder to refill basic fuel level. This parameter can be found in:

### Menu → Service settings → Burner settings

## 8.22 INFORMATION

Menu information enables view to measured temperatures and allows to check which of devices are currently activated. Switching between following screens is done by twisting “TOUCH and PLAY” knob.

After connecting extension module of mixers information about auxiliary mixers are displayed



Writing „CAL“ in information window of mixer by position valve opening level stands for active process of its calibration. It is necessary to wait until calibration of mixer valve servomotor is completed. Then its current state will be displayed.



### 8.23 MANUAL CONTROL

In the controller it is possible to manually activate devices like i.e. pumps, feeder engine, or blower engine. It enables to check if the device is operating correctly and if it is connected properly.



Entering manual control is possible only in STAND-BY mode, when silo is switched off

<b>Manual control</b>	
<b>Fan</b>	<b>ON</b>
<b>Feeder</b>	<b>OFF</b>
<b>Boiler pump</b>	<b>OFF</b>
<b>Lighter</b>	<b>ON</b>
<b>Feeder 2</b>	<b>OFF</b>
<b>Serv.supply</b>	<b>OFF</b>

OFF – the device is turned off, ON – the device is turned on.



Attention: long lasting activating of fan, feeder or other device may cause danger.





USER MANUAL OF CONTROLLER INSTALLATION AND SERVICE SETTINGS

# ecoMAX850P2-C

---



## 9 HYDRAULIC SCHEMES



The following sample schemes do not replace the system design of CH, HUW. They are used for illustrative purposes only.

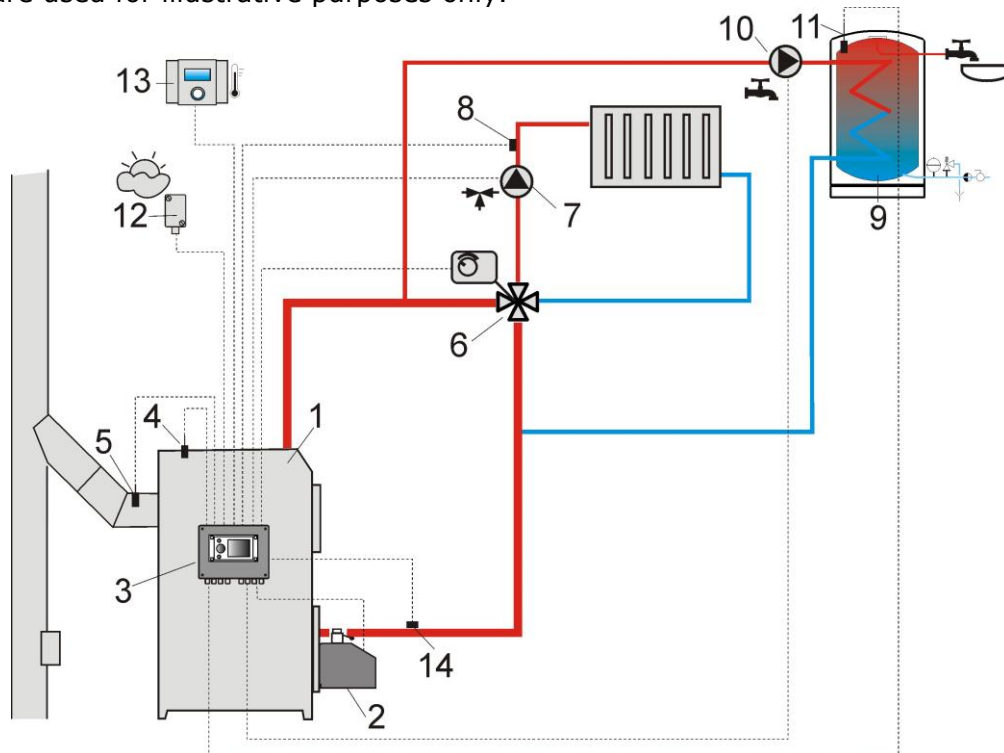

**Scheme with 4 way steering valve controlling central heating circuit<sup>2</sup>**, where: 1 – boiler, 2 – burner, 3 – controller, 4 – boiler temperature sensor, CT4, 5 – fumes temperature sensor, 6 – servomotor of 4 way valve, 7 – mixer cycle pump, 8 – mixer cycle temperature sensor, 9 – silo of hot water, 10 – hot water pump, 11 – hot water sensor, 12 – weather temperature sensor CT4-P, 13 – room panel ecoSTER200 or standard room thermostat, 14 – return temperature sensor (it is not necessary to operate the system).



To improve water circulation in gravity cycle it is necessary to use large nominal profiles DN of a pipe and 4 way valve, not to use large amount of knees and profile narrowings. Use other rules referring to gravity installations. If return sensor is installed closely, it is necessary to isolate it thermally from surroundings and improve thermal contact with pipe. Preset silo temperature must be set so high to ensure thermal power for mixer cycle when at the same time heating water returning to the silo.

### RECOMMENDED SETTINGS:

Parameter	Setting	MENU
Preset boiler temperature	75-80°C	menu→boiler settings
Min. preset boiler temperature	65°C	menu→service settings→ boiler settings
Increase preset boiler temperature	5-20°C	menu→service settings→ CH and HUW settings
Mixer handling 1	CH activated	menu→service settings→ mixer 1 settings
Max. Preset mixer temperature 1	70°	menu→service settings→ mixer 1 settings
Mixer heating curve 1	0.8 – 1.4	menu→mixer 1 setting
Mixer Weather control 1	activated	menu→mixer 1 setting
Selection of mixer thermostat 1	ecoSTER T1	menu→service settings→ mixer 1 settings

<sup>2</sup>Shown hydraulic scheme does not replace the project of central heating and serves only as a sample!

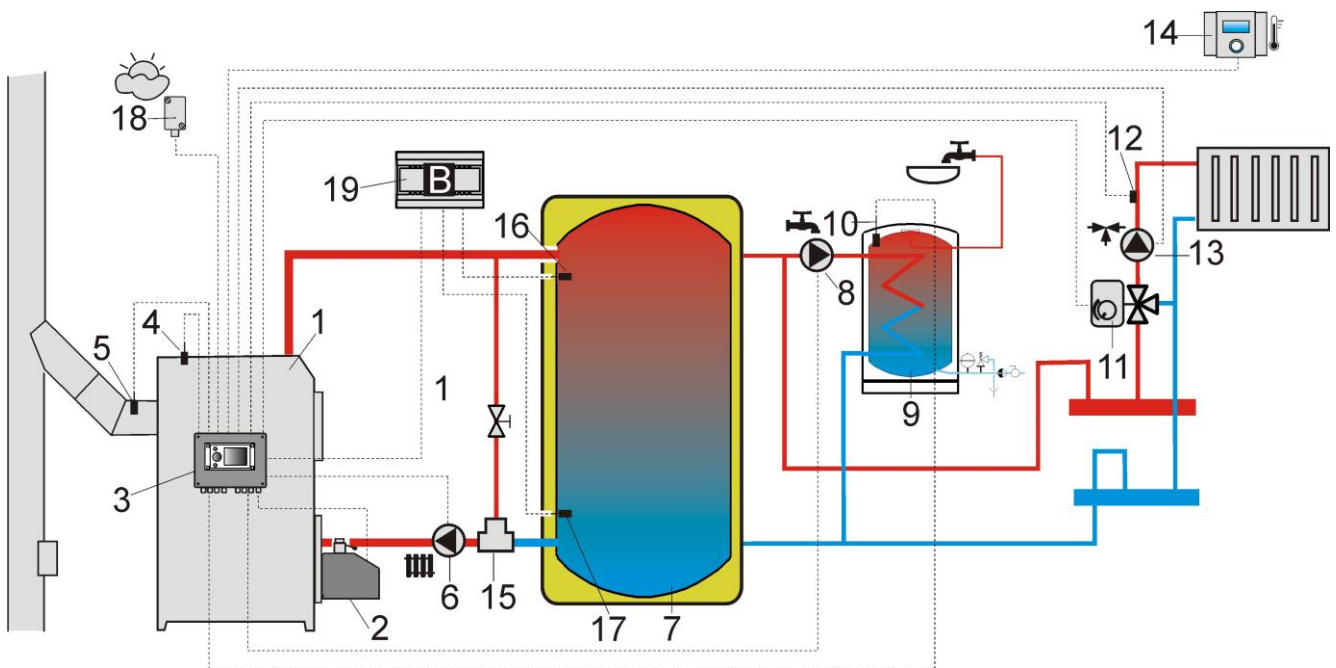

**Scheme with heating buffer<sup>3</sup>**, where: 1 – boiler, 2 – burner, 3 – controller, 4 – boiler temperature sensor, 5 – fumes temperature sensor, 6 – boiler pump, 7 – heating buffer, 8 – hot water pump, 9 – hot water silo, 10 – hot water temperature sensor, 11 – servomotor of mixing valve, 12 – room mixer temperature sensor, 13 – mixer pump, 14 – room panel ecoSTER200 with room thermostat function, 15 – thermostatic 3 way valve for return protection, 16 – buffer higher temperature sensor, 17 – buffer lower temperature sensor, 18 – weather temperature sensor, 19 – additional module B.

RECOMMENDED SETTINGS:

Parameter	Setting	MENU
Preset boiler temperature	80°C	menu→boiler settings
Min. preset boiler temperature	75°C	menu→service settings→ boiler settings
CH pump activating temperature	55°C	menu→service settings→ CH and HUW settings
Activating operation (buffer service)	activated	menu→ service settings→ buffer settings
Buffer loading start temperature	50	menu→ service settings→ buffer settings
Buffer loading stop temperature	75	menu→ service settings→ buffer settings
Mixer service 1	activated CO	menu→service settings→mixer 1 settings
Max mixer preset temperaturę 1	70°	menu→service settings→mixer 1 settings
Mixer heating curve 1	0.8 - 1.4	menu→ mixer 1 settings
Mixer weather control 1	activated	menu→mixer 1 settings
Mixer thermostat selection 1	ecoSTER T1	menu→service settings→ mixer 1 settings

<sup>3</sup> Shown hydraulic scheme does not replace the project of central heating and serves only as a sample!



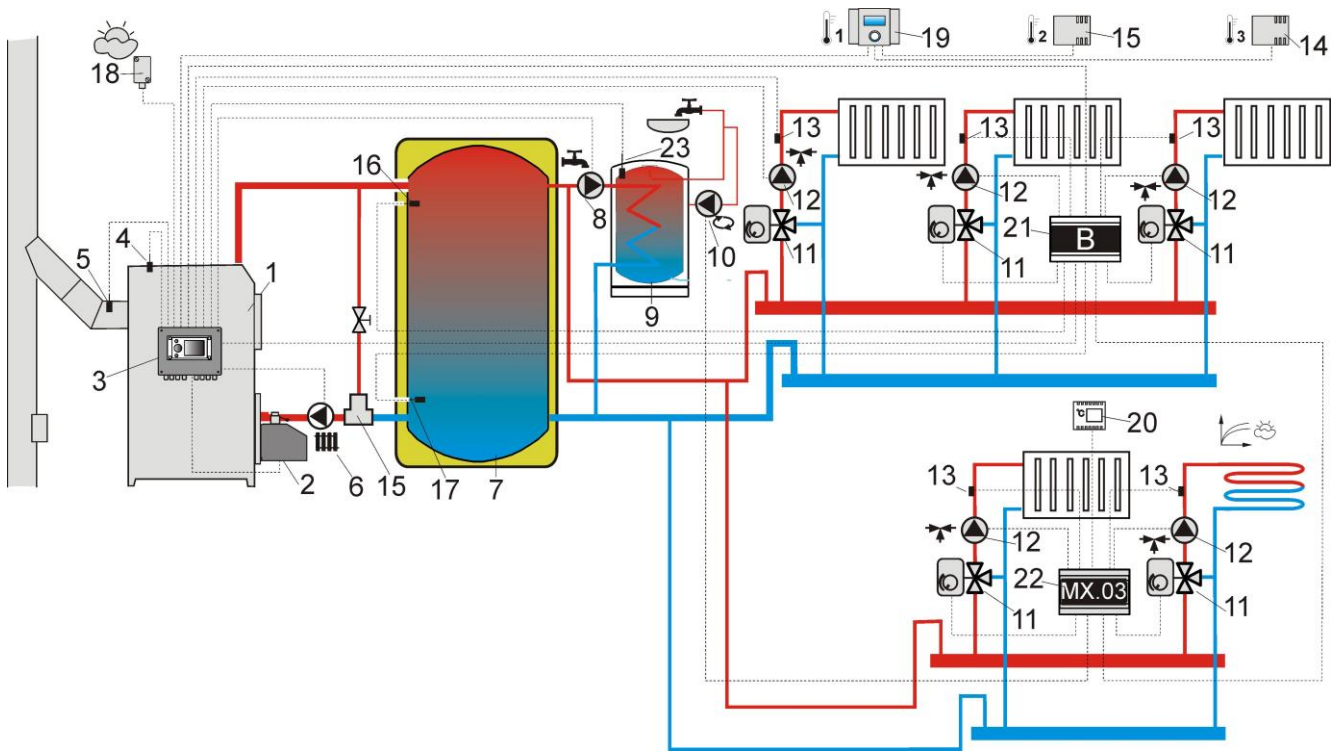

**Scheme with heating buffer and 5 mixing heating circuits<sup>4</sup>**, where: 1 – boiler, 2 – burner, 3 – controller, 4 – boiler temperature sensor CT4, 5 – fumes temperature sensor CT2S, 6 – boiler pump, 7 – heating buffer, 8 – hot water pump, 9 – hot water silo, 10 – circular pump, 11 – 3 way valve with servomotor, 12 – mixer cycle pump, 13 – mixer cycle mixer sensor, 14 – room sensor CT7, 15 – room sensor CT7, 16 – higher sensor of buffer temperature, 17 – lower sensor of buffer temperature, 18 – weather temperature sensor CT4-P, 19 – room panel ecoSTER200 with room thermostat function, 20 – standard room thermostat, 21 – additional module B, 22 – additional module MX.03, 23 – hot water room temperature .

RECOMMENDED SETTINGS:

Parameter	Settings	MENU
Boiler preset temperature	80°C	menu→boiler settings
Min. preset boiler temperature	75°C	menu→service settings→ boiler settings
CH pump start temperature	55°C	menu→service settings→ HUW and CH settings
Activate operating (buffer service)	active	menu→ service settings→ buffer settings
Buffer loading start temperature	50	menu→ service settings→ buffer settings
Buffer loading stop temperature	75	menu→ service settings→ buffer settings
Mixer service 1,2,3,4	active CH	menu→service settings→mixer 1...4 settings
Max. Mixer preset temperature 1,2,3,4	70°	menu→service settings→mixer 1...4 settings
Mixer heating curve 1,2,3,4	0.8 – 1.4	menu→mixer 1...4 settings
Mixer weather control 1,2,3,4	active	menu→mixer 1...4 settings
Mixer thermostat selection 1	ecoSTER T1	menu→service settings→ mixer 1 settings
Mixer thermostat selection 2	ecoSTER T2	menu→service settings→ mixer 2 settings
Mixer thermostat selection 3	ecoSTER T3	menu→service settings→ mixer 3 settings
Mixer thermostat selection 4	universal	menu→service settings→ mixer 4 settings
Mixer service 5	Activate floor	menu→service settings→mixer 5 settings
Max. Mixer preset temperature 5	50°	menu→service settings→mixer 5 settings
Mixer heating curve 5	0.2 – 0.6	menu→ mixer 5 settings
Mixer weather control 5	active	menu→mixer 5 settings

<sup>4</sup>Shown hydraulic scheme does not replace the project of central heating and serves only as a sample!

## 10 TECHNICAL DATA

Power	230V~; 50Hz;	
Current consumed by controller	I = 0,04 A	
Maximum nominal current	6 (6) A	
Controller's level of protection	IP20	
Outer temperature	0...50 °C	
Storage temperature	0...65 °C	
Relative humidity	5 - 85% without condensation of water steam	
Measuring scope of sensors' temperature CT4	0...100 °C	
Measuring scope of sensors' temperature CT4-P	-35...40 °C	
Accuracy of measuring temperature with sensors CT4 and CT4-P	2 °C	
Clamps	For network and signal	Screw clamps, wire profile up to 2,5mm <sup>2</sup> , tighten moment 0,4Nm, isolation length 7mm
	protecting	Screw clamps, wire profile up to 2,5mm <sup>2</sup> , tighten moment 0,5Nm, isolation length 6mm
Display	Graphic 128x64	
Dimensions	224x200x80 mm	
Weight	1,4 kg	
Norms	PN-EN 60730-2-9 PN-EN 60730-1	
Software class	A	
Protection class	For installing to devices class I	
Level of contamination	2 wg PN-EN 60730-1	

## 11 STORAGE AND TRANSPORT

## CONDITIONS

The controller can not be exposed to immediate effects of atmospheric conditions i.e. rain or sunrays. Temperature of storage and transport should be within scope -15...65 degrees C.

During transport the controller can not be exposed to vibrations bigger than typical for transport of boilers.

## 12 CONTROLLER INSTALLATION

### 12.1 ENVIRONMENTAL CONDITIONS

Due to fire risk it is forbidden to use the controller in proximity of explosive gases or dust. Moreover the controller can not be used in conditions of water steam condensation or be exposed to effects of water.

### 12.2 Wymagania montażowe

The controller should be installed by a qualified and authorized installer, in accordance with current norms and regulations.

The producer is not responsible for damages caused by failing to observe valid law and this user manual.

The controller is designed to be built-in. This means that it is attached to flat and stable part of a boiler or a wall. It can not be used as a separate device. Leave free space at each partition of the controller (save for assembly partition) at least 50mm. Leave free space allowing for setting wires without bending them, at least 100mm from back partition of the controller. Outer temperature and assembly surface should be within scope of 0 – 50 degrees C.

### 12.3 INSTALLATION

The controller is adapted to be installed on flat assembly surface. In order to screw it to assembly surface please undo the screws (3) and carefully lift the cover (1), then undo the plug (4). Then remove the cover (1) in a safe place. Using screws (5) stuck through holes in the cover (2) screw the controller to assembly surface (6).

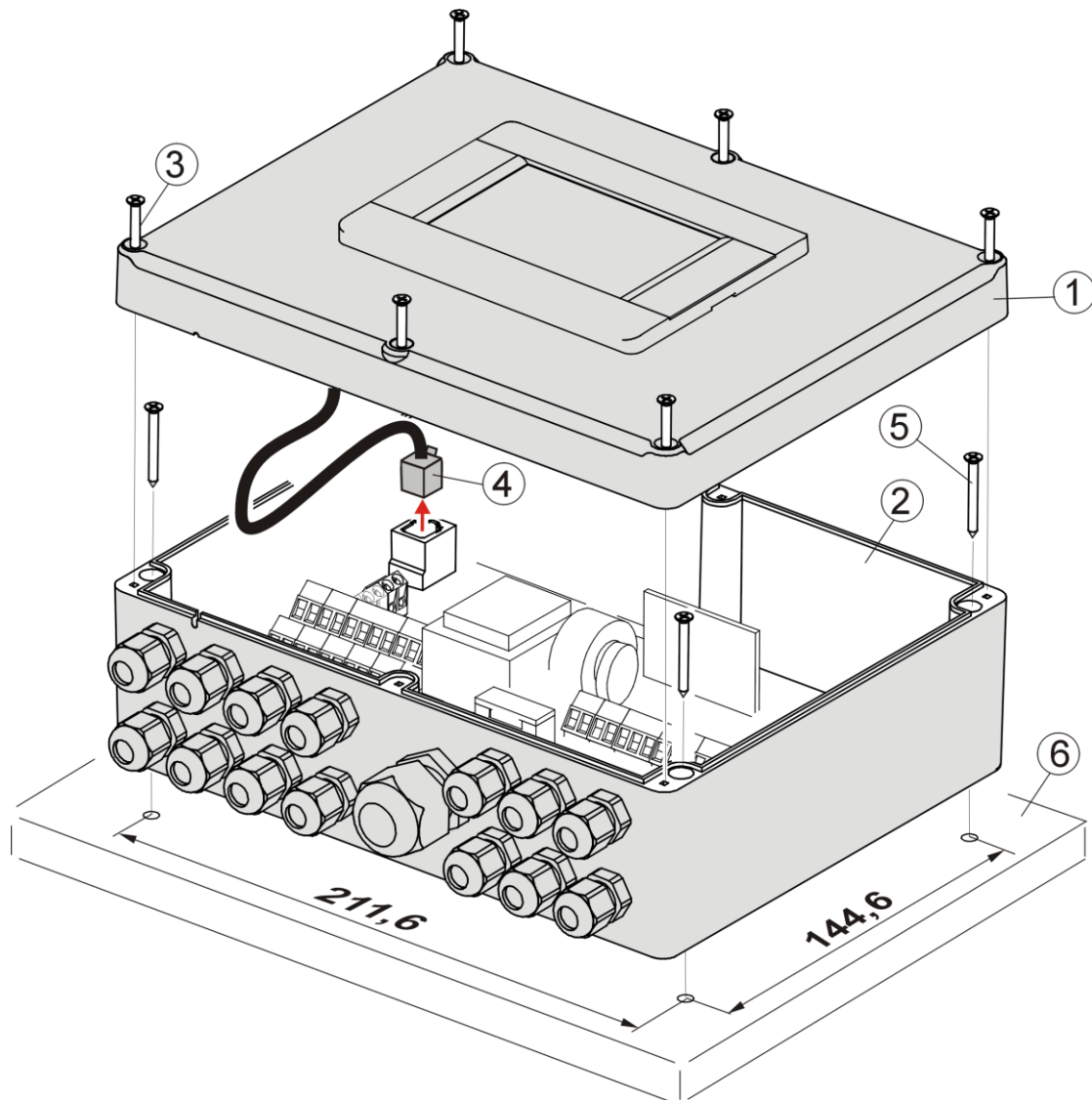

Embedding controller on assembly surface, where: 1 – cover, 2 – base, 3 – screw for cover, 4 – plug, 5 – screw for assembly surface, 6 – assembly surface.

### 12.4 ELECTRIC CIRCUIT CONNECTION

The controller is adapted to current 230V~, 50Hz. Features of installation:

- 3 way (with protecting wire),
- made according with valid law.



After deactivating the controller with the keypad, there still can be a dangerous voltage on the connections. Before starting assembly works it is obligatory to disconnect the electrical power and make sure that there is no danger electrical power on claps and wires.

Connecting wires should not touch with surfaces with temperatures exceeding nominal temperature of their work. Claps on the right side of the device are marked as L, N, 1-19 are designed to connect devices powered with current 230V~. Claps 20-40, D+, D- and RJ are designed to cooperate with low voltage devices (below 12V).



Connecting current 230V to claps 20 – 40 and transmission connections causes damage to the controller and brings danger of electrical shock!

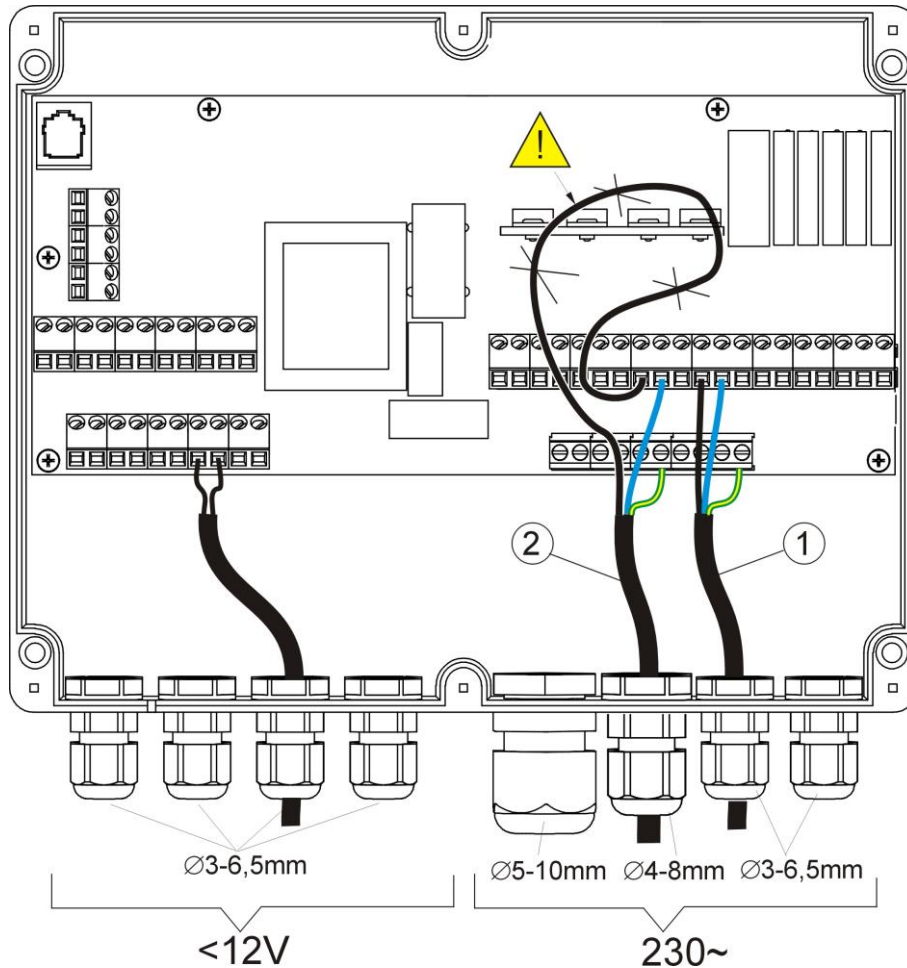

Wire connection, where 1 – correctly connected wire, 2 – incorrectly connected wire (it is not acceptable to twist wires inside the device)

Wires inside the controller should be led through cable glands. Cable glands should be screwed. Make sure that glands are correctly screwed by pulling wire. Length of isolation of external tire of wires should be minimal, maximum 60mm. If it is necessary to longer isolate the wire tire they should be connected with each other or other wires close to the connector. In this case when a wire gets loose from the connector it is not in contact with dangerous parts. Isolation length of wires entering connections are shown in the table in point 10. It is not acceptable to twist wires and leaving unconnected wires inside the controller (risk of contact with hot parts and parts with dangerous voltage).

## 12.5 SAFETY CONNECTIONS

Safety wires are to be connected with terminals marked with this symbol .

## 12.6 ELECTRIC SCHEME

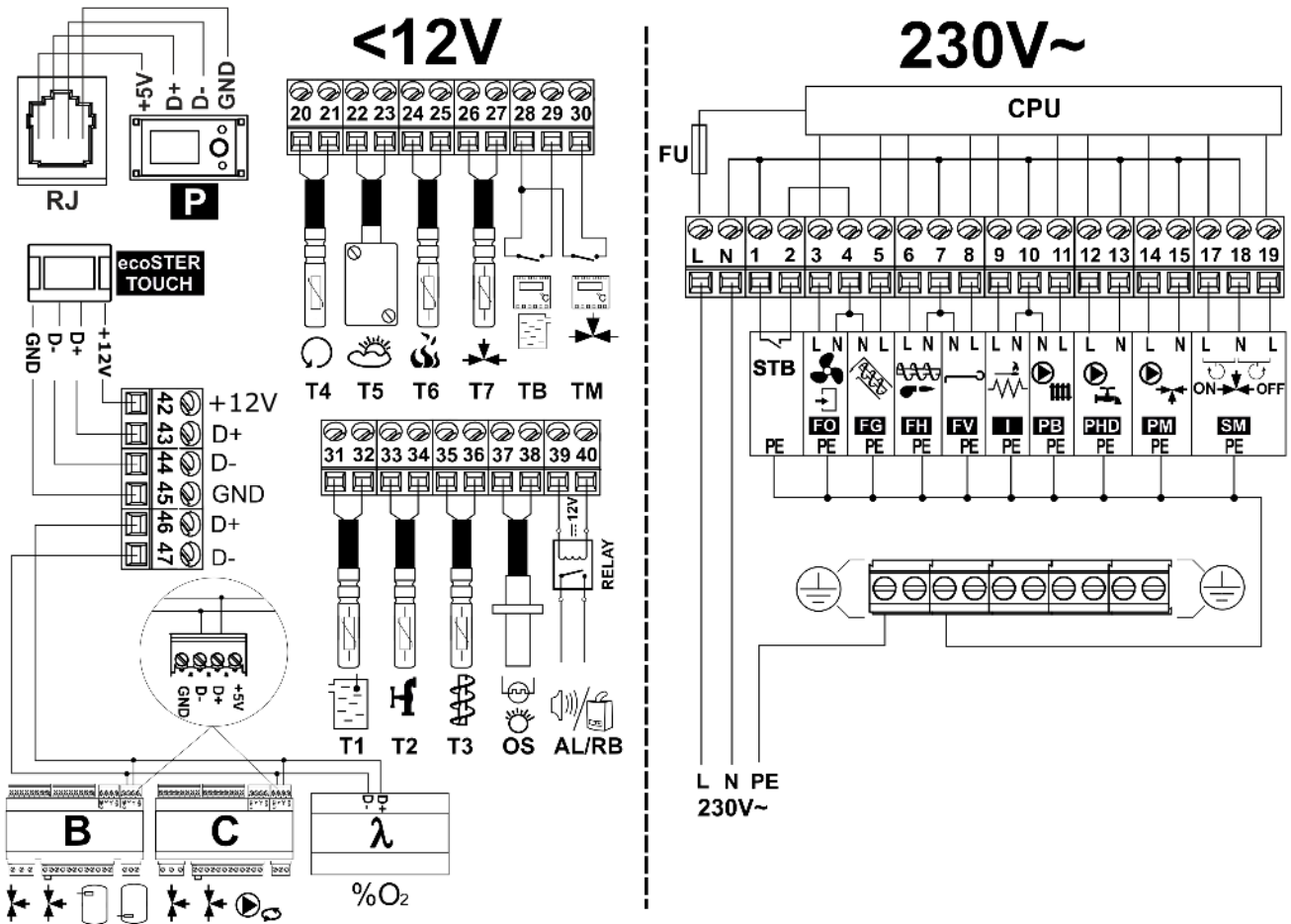

**Scheme of electrical connections of the controller**, where: T1 – boiler temperature sensor CT4, T2 – hot water temperature sensor CT4, T3 – feeder temperature sensor, OS – flame optical sensor, AL/RB – currency exit to alarm signal or steering the auxiliary silo, RELAY – transmitter, T4 – boiler return temperature sensor CT4, T5 – weather temperature sensor CT4-P, T6 – fumes temperature sensor CT2S, T7 – mixer temperature sensor, TB – connection of mixer room thermostat, P – controlling panel, ecoSTER200 – room panel with room thermostat function (replacing TB or TM), D-D+ - connection to additional modules, B – module B allows to service additional two mixer cycles and heating buffer cycle, MX.03 – additional module allows to service two additional mixers and circular pump, A – Lambda sond module, L N PE – electrical power 230V, FU – fuse, STB – connection to limiter of safety temperature, FO – blowing fan of the controller, FG – main feeder, FH – feeder of the burner, I – igniter, PB – boiler or buffer pump, PHD hot water pump, FV – pulling fan of the boiler, PM – mixer pump, SM – mixer servomotor, CPU – controlling.

## 12.7 TEMPERATURE SENSORS CONNECTION

Wires of the sensors can be extended by wires with diameter not smaller than 0,5mm<sup>2</sup>. Total length of wires in each sensor should not exceed 15m.

Boiler temperature sensor should be installed in thermostatic pipe installed in boiler. Temperature sensor of hot water silo should be installed in thermostatic pipe welded into the silo. Mixer temperature sensor should be installed in sleeve located in stream of running water in pipe, but also it can be installed on the pipe, on condition that it is thermo isolated from the pipe.



Sensor must be protected from getting loose from the surfaces to which they are connected.

Good thermo contact should be maintained between sensors and measured surface. To this purpose thermoleading paste should be used. It is not acceptable to lubricate sensors with water or oil. Wires of sensors should be separated from network electrical wires. In such a case wrong readings of temperature may be shown. Minimum length between those wires should be 10cm. It is not acceptable to allow for contact between wires of the sensors and hot parts of the boiler and heating installation. Wires of the sensors are resistant to temperature not exceeding 100 degrees C.

## 12.8 WEATHER SENSORS CONNECTION

The controller cooperates solely with weather sensor type CT4-P. The sensor should be installed on the coolest wall of the building. Usually it is the northern wall, under the roof. The sensor should not be exposed to direct sunrays and rain. The sensor should be installed at least 2 m above the ground far away from windows, chimneys and other sources of heat which could disturb the temperature measurement.

To connect use wire with diameter at least 0,5mm<sup>2</sup> up to 25m long. Polarization of wires is not essential. Second end should be

connected to terminals of controller or properly to used kind of controller.

The sensor should be screw to the wall. Acces to assembly holes is possible after unscrewing the cover of the sensor.

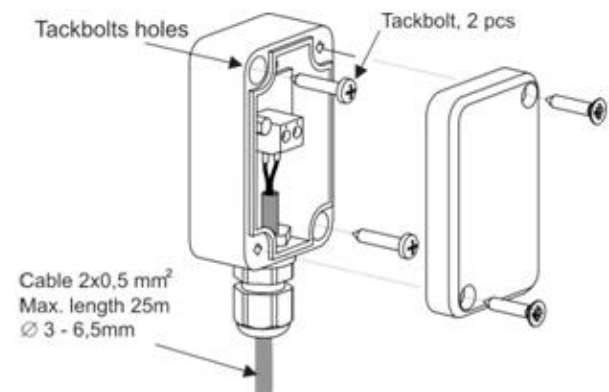

## 12.9 WEATHER SENSORS CHECKING

Temperature sensors CT4/CT4-P can be checked by measuring their resistance in given temperature. In case of big differences between measured resistance value and values in table below, the sensor should be replaced with a new one.

CT4			
Weather temperature °C	Min. Ω	Nom. Ω	Max. Ω
<b>0</b>	802	<b>815</b>	828
<b>10</b>	874	<b>886</b>	898
<b>20</b>	950	<b>961</b>	972
<b>25</b>	990	<b>1000</b>	1010
<b>30</b>	1029	<b>1040</b>	1051
<b>40</b>	1108	<b>1122</b>	1136
<b>50</b>	1192	<b>1209</b>	1225
<b>60</b>	1278	<b>1299</b>	1319
<b>70</b>	1369	<b>1392</b>	1416
<b>80</b>	1462	<b>1490</b>	1518
<b>90</b>	1559	<b>1591</b>	1623
<b>100</b>	1659	<b>1696</b>	1733

CT2S-2 fumes			
Temp. °C	Min. Ω	Nom. Ω	Max. Ω
0	999,7	1000,0	1000,3
25	1096,9	1097,3	1097,7
50	1193,4	1194,0	1194,6
100	1384,2	1385,0	1385,8
125	1478,5	1479,4	1480,3

150	1572,0	1573,1	1574,2
-----	--------	--------	--------

CT4-P (weather)			
Temp. °C	Min. Ω	Nom. Ω	Max. Ω
-30	609	<b>624</b>	638
-20	669	<b>684</b>	698
-10	733	<b>747</b>	761
0	802	<b>815</b>	828
10	874	<b>886</b>	898
20	950	<b>961</b>	972

### 12.10 OPTICAL SENSOR CONNECTION

Connect the sensor accordingly to point 12.6. Readings of data from optical sensor is possible in menu:

**Menu → Information → Flame**

### 12.11 MIXERS ROOM TEMPERATURE CONNECTION

Room thermostat after disconnecting wires reduces preset temperature of the value of reduction the preset temperature of the mixer from the thermostat. Parameter is in menu:

**Menu – Mixer settings 1,2,3,4,5 – Mixer room temperature**

Value of parameter should be chosen in such a way that after activating room thermostat, temperature in the room should decrease. Other settings according to point 8.16.

In case of room panel ecoSTER200 make sure that this parameter is correctly chosen:

**Menu – Service settings – Mixer settings 1,2,3,4,5 – Mixer room thermostat**

### 12.12 BOILER ROOM THERMOSTAT CONNECTION

Room thermostat for boiler circuit can switch off the burner operation or switch off the CH boiler pump. In order to thermostat switch off boiler operation select *Thermostat selection* for *universal* or *ecoSTER T1* (if room panel ecoSTER200 is connected)

**Menu → Service settings → Boiler settings → Thermostat selection.**

For thermostat switch on the CH boiler pump (without switching off the boiler) set the parameter *Thermostat pump deactivating* on YES

**Menu → Service settings → Boiler settings → Pump off by thermostat**

### 12.13 RESERVE BOILER CONNECTION

The controller can control work of additional (gas or oil) boiler. It is not necessary then to manually activate or deactivate this boiler. Additional boiler will be activated when boiler for pellet loses temperature and will deactivate when pellet boiler reaches its proper temperature. Connection to additional boiler should be done by a qualified installer, according to technical data of this boiler. The additional (spare) boiler should be connected by transmitters with terminals 39-40.

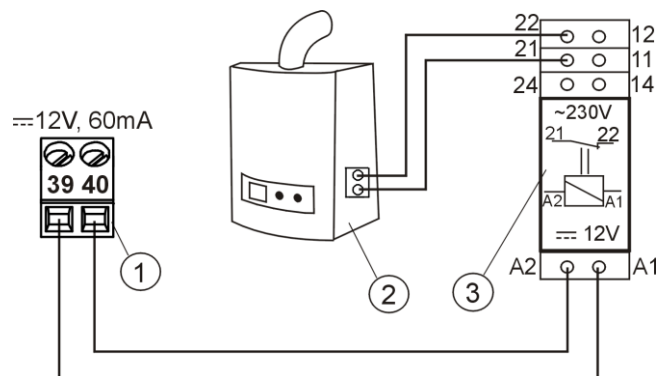

Sample scheme of system for additional boiler connection to the controller, where: 1 – module B, 2 – additional boiler (for oil or gas), 3 – transmitter RM 84-2012-35-1006 and holder GZT80 RELPOL

The controller is not equipped with transmitter as standard option.



Assembly of transmitter should be done by a person with proper qualifications. According to valid norms and regulations.

To activate control over additional boiler set the parameter *Reserve boiler deactivation temperature* on value different than zero.

**Menu → Service settings → Boiler settings → Reserve boiler**

Deactivating control over additional boiler is done after setting zero value of switching off for this parameter.



Controlling extension of the boiler is coshared with alarm extension. Deactivating additional boiler control will cause that this extension will be controlled by module of controlling alarms.

In case when terminals 39-40 are connected with additional boiler and additional boiler control is deactivated (by selecting zero value of its switching off temperature) then it is required that *code of signaling active alarms* is set for value 0

**(Menu → Service settings → Boiler settings → Alarms).** It is to protect against situation when reporting alarms compatible with alarm signal codes causes activation of additional boiler.

When pellet boiler is fired-up, and its temperature exceeds preset value i.e. 25 degrees C, then controller switches off additional boiler (it will give constant power AC 6V for terminals 39-40) It will power the coil of transmitter and disconnecting its joints. After decreasing boiler temperature below parameter temperature of additional boiler switching off the controller stops giving power to joints 39-40 which should activate the additional boiler.



Switching the controller into STAND-BY mode causes deactivating the additional boiler.

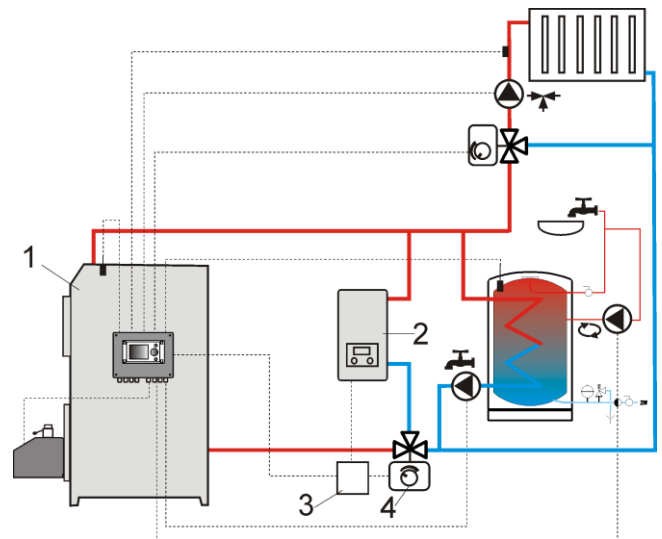

Hydraulic scheme with additional boiler in open – closed circuit, where: 1- controller, 2- additional boiler, 3- transmitter, 4- switching valve (with end switchers)

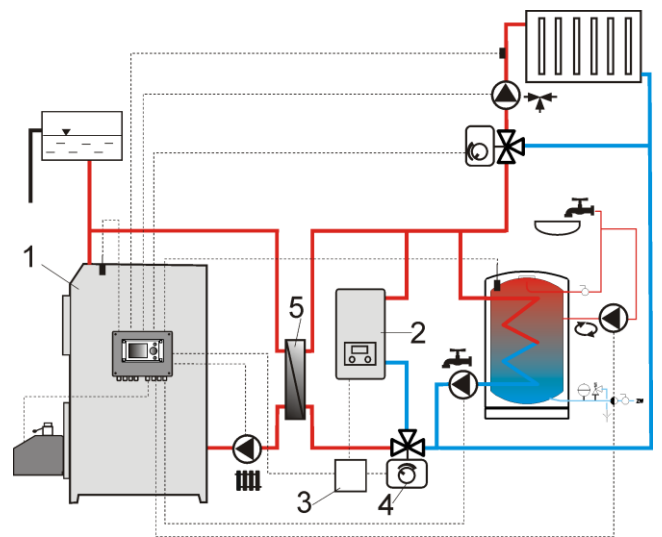

Hydraulic scheme with additional boiler in open – closed circuit, where: 1- controller, 2- additional boiler, 3- transmitter, 4- switching valve (with end switchers), 5- heat exchanger, recommended setting: priority HW = deactivated, heat exchanger = YES.



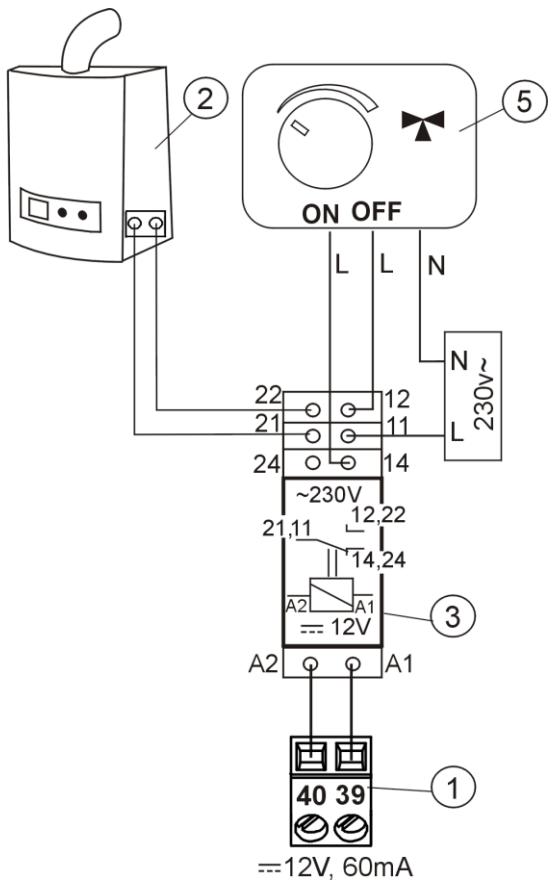

Electrical scheme of controlling the switching valve of additional boiler, where: 1- controller, 2- additional boiler, 3- transmitter, 5- servomotor of switching valve (with end switchers), attention: terminals 22, 21, 24 must be separated by galvanizing from terminals 12, 11, 14.

### 12.14 ALARMS SIGNAL CONNECTION

The controller can report alarms by activating external devices like ring or GSM device to short messages SMS sending. Alarm signaling device must be connected through a relay. On the matter that output is shared with reserve boiler control output, in order to activate the output for alarm function, you must first disable the reserve boiler control. To do this you should in the menu:

Service settings → Boiler settings → Reserve boiler  
 Set zero value of its deactivating temperature.

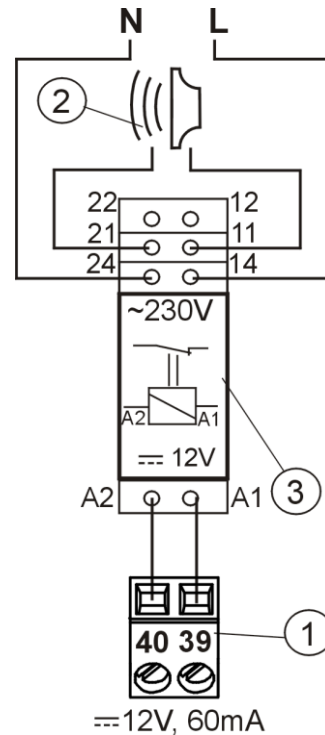

External alarm device connection, where: 1 - controller, 2- external alarm device, 3- transmitter.

Then in order to operate correctly set proper code for active alarms signal in menu:

**Menu → Service settings → Boiler settings → Alarms**

Choosing value „127” causes activating electrical power between joints 39-40 (connecting alarm extension) in event of any of the alarms. Setting this parameter for “0” will cause that the controller will not connect extension by any of the alarms.

It is also possible to configure alarm extension in such a way to connect it when selected alarm appears. Value of this parameter for selected alarms is shown in the table:

Exceeding boiler temperature	Exceeding feeder temperature	CH boiler temperature sensor damage	Feeder temperature sensor damage	Fire-up failed attempt
AL 2	AL 3	AL 4	AL 5	AL6
<b>2</b>	<b>4</b>	<b>8</b>	<b>16</b>	<b>32</b>

Example: Setting value of parameter for "8" extension will be activated with alarm AL4. Setting value for "2" extension will report only alarm AL2. In case when extension is to report several alarms set the parameter to value which is a sum of values from the table referring to respective alarms (2+8=10). If any of alarms is to be reported AL2, AL3 – set parameter for "6".

### 12.15 MIXER CONNECTION



During assembly works for mixer servomotor pay attention not to overheat the boiler. This may happen when there is a limited flow of water from the boiler. It is recommended to check the location of valve in maximum opening before starting work, to ascertain heat acceptance from the boiler by opening the valve to maximum.

The controller cooperates only with servomotors of mixing valves equipped with end switchers. Using other servomotors is forbidden. Servomotors with full circle scope of 30 to 255s can be used.

Connecting mixer description:

- Connect mixer temperature sensor
- Connect electrical mixer pump
- Activate the controller and select in service menu proper *mixer service*

**MENU → SERVICE SETTINGS → Mixer 1 settings**

- set in mixer service settings proper time of valve opening (time should be written on data plate of servomotor, i.e. 120s).
- Connect electrical power of the controller and activate it so the mixer pump is working,
- Choose the direction in which servomotor opens and closes. To do so, switch the button to manual control and find position in which temperature in mixer circuit is maximal (in controller it is position 100% ON) and value position when temperature of mixer circuit is minimal (in controller it is position 0% OFF). Remember the position in order to later verification of proper connection,
- Disconnect the electrical power to the controller
- Connect electrical power to mixer servomotor with the controller, according to point 12.4 and value servomotor producer's documentation. Do not confuse opening direction with closing direction,
- Connect electrical power to the controller and switch it into STAND-BY mode
- Check if wires for mixer opening and closing are not swapped. Go into:

**MENU → Manual control** and open mixer by selecting **Mixer 1 Opening = ON**. By opening servomotor temperature on the mixer sensor should increase. If not, disconnect the power and swap wires. (attention: another cause may be incorrectly connected valve! – check the producer's documentation if it is properly connected),

- Set other parameters of the mixer according to point 14.5

#### Calibration of valve indicator position:

Indicator of valve position is in the menu: **MENU – Information**. For mixer 1 after some time it will calibrate automatically. In order to make the valve position indicator displaying quicker the right value, disconnect

the electrical power of the controller, than in cover of the controller switch the button into manual control. Turn the cap of the valve into closed position, then again switch the button in the cover into AUTO. Connect the electrical power to the controller - % indicator of valve opening is calibrated. Attention, in mixers No 2,3,4,5 calibration is automatic after connecting electrical power. In case of these mixers wait until indicator of valve opening is calibrated in %. During calibration the servomotor is closed through *valve opening time*. The calibration is displayed in MENU – Information – mixer info – “CAL”

### 12.16 CIRCULAR PUMP CONNECTION

Circular pump can be connected to boiler controller only by extension module C.

### 12.17 TEMPERATURE LIMITER CONNECTION

In order not to overheat the boiler due to the controller breakdown it is obligatory to use STB safety temperature limiter or any other one suitable for given boiler. Limiter STB should be connected to terminals 1-2. When limiter is activated, blowing is stopped as well as engine of fuel feeder.



Safety temperature limiter must have nominal voltage at least 230V and should have valid admission documents

In case of not installing the limiter terminals 1-2 are to be connected by a bridge. The bridge must be made with insulated wire, with diameter at least 0,75mm<sup>2</sup>. With insulation which is thick enough to meet safety standards of the boiler.

### 12.18 ROOM PANEL CONNECTION

It is possible to equip the controller with room panel ecoSTER200, which has following functions: room thermostat (controls up to 3 thermostats), controlling panel for the boiler, alarm signal, fuel level indicator



The maximum cable length from the terminal regulator to the room panel should not exceed 30 m and the cross section of of veins should not be less than 0.5 mm<sup>2</sup>.

- **4 way connection**

TOUCH ecoSTER connection must be in accordance with the wiring diagram while ecoSTER200 connect as shown below.

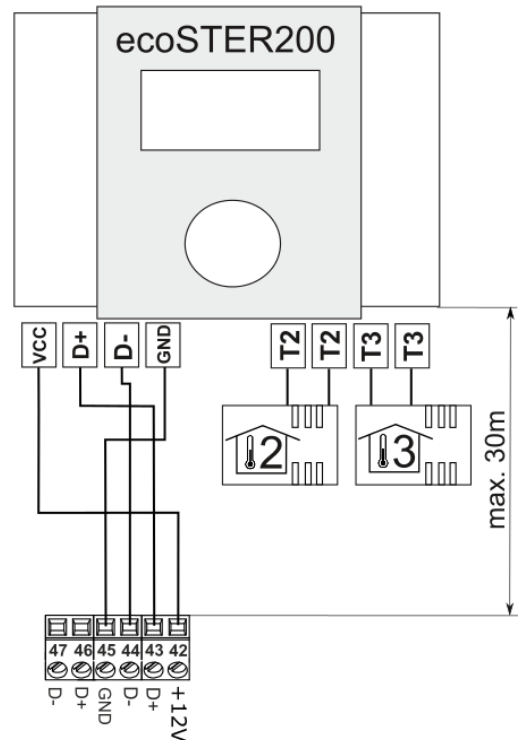

- **2 way connection**

This connection requires the use of an external power supply 12V DC with a current of min. 200 mA. The panel points ecoSTER200 / ecoSTER TOUCH: GND and VCC / + 12V connected to the power supply. The lines D +, D- connected according to the wiring diagram and drawing for 4-wire connection.

The power supply is not included with the controller.

## 13 SERVICE MENU

Service settings
Burner settings
Boiler settings
CH and HUW settings
Buffer settings *
Mixer settings 1-5*
Show advanced setup
Service counters
Restore service settings

Burner settings
Firing-up
<ul style="list-style-type: none"> <li>Ignition test time</li> <li>Fuel dose</li> <li>Flame detection</li> <li>Firing-up airflow</li> <li>Firing-up time</li> <li>Blowing after firing up                             <ul style="list-style-type: none"> <li>Blow-in p. after after infl.</li> </ul> </li> <li>Heating up time</li> <li>Worktime with minimal power</li> </ul>
Operation
<ul style="list-style-type: none"> <li>Thermostat mode</li> <li>Cycle time OPERATION</li> <li>Fuel calorific</li> <li>Capacity of tank</li> <li>Extending time of feeder 2 work</li> </ul>
Burning off
<ul style="list-style-type: none"> <li>Maximum time of burning off</li> <li>Minimum time of burning off</li> <li>Air flush intensity</li> <li>Blowing time</li> <li>Blowing pause</li> <li>Blowing start</li> <li>Blowing stop</li> </ul>
Cleaning
<ul style="list-style-type: none"> <li>Cleaning time Firing-up</li> <li>Cleaning time burning off</li> <li>Cleaning blowing</li> <li>Rotary cleaning cycle</li> </ul>
Supervision
<ul style="list-style-type: none"> <li>Supervision time</li> <li>Boiler output</li> <li>Cycle time</li> <li>Fan output</li> </ul>
Grate *
<ul style="list-style-type: none"> <li>Blowing power - supervision</li> <li>Blowing pause - supervision</li> </ul>

Min. airflow output
Fuel shortage detection time
Maximum feeder temperature
Operation time of additional feeder

Boiler settings
Thermostat select.:
Return protection *
Minimum boiler temperature
Maximum boiler temperature
Reserve boiler
Alarms
Boiler cooling temperature
Parameter A,B,C FL
Off by thermostat

CH and HUW settings
CH pump activation temperature
CH standstill when loading HUW *
Minimum HUW temperature *
Maximum HUW temperature *
Boiler inc. by HUW, Mixer
Extending HUW pump operation time *
Circulating pump standstill time *
Circulating pump operation time *
Exchanger *

Buffer settings *
Activate operation
Loading start temperature
Loading end temperature

Mixer settings 1-5*
Mixer support
<ul style="list-style-type: none"> <li>Off</li> <li>CH on</li> <li>Floor on</li> <li>Pump only</li> </ul>
Thermostat select. *
Min. mixer temp.
Max. mixer temp.
Valve full opening time
Off by thermostat
Mixer input dead zone *

\* Not available if proper sensor not attached, extension module or parameter is hidden.

## 14 SERVICE SETTINGS

### 14.1 BURNER

<b>Burner settings</b>	
<b>Firing up</b>	Description
Ignition test time	Time for checking if furnace is hot. Only fan is operating.
Fuel dose	Fuel dose during firing up. Concerns first testing firing up. Next tests fuel dose is reduced(20% of basic dose)
Flame detection	Threshold of flame detection in % of light, when the controller deems the furnace as hot. It is also used for detection of lack of fuel and end of burning off.
Firing-up airflow	% of blowing when firing up. Too big value prolongs the firing up proces or causes failed attempt of firing up.
Firing-up time	Time of following firing up attempts (3 attempts). After that time the controller goes to another firing up attempt.
Blowing after firing up	% of fan blowing after flame detection.
Blowing p. after inflame	Fan operation time with power <i>Blowing after firing up</i> .
Igniter period	Igniter warming up time before engaging the fan. It should not be too long as to not damage the heater. After this time the heater works still until detecting the flame.
Worktime with minimal power	Burner operation time with minimum power 30% after firing up. Power is determined by parameter: <i>Blowing power 30%</i> and <i>feeder operation time 30%</i> , in menu: boiler settings – output modulation.
<b>Operation</b>	
Thermostat mode	Switches the burner into THERMOSTAT mode, i.e. for working in bakery. The burner operates with maximum power without modulation of power. The burner deactivates with disconnecting thermostat joints 28-29. Boiler temperature sensor does not influence feeder operation.
Cycle time OPERATION	Time of whole fuel feeding cycle in OPERATION mode. <i>OPERATION mode time = feeding time OPERATION + feeder pause time.</i>
Fuel calorific	Fuel calorific in kWh/kg.
Capacity of tank	Fuel silo capacity for counting fuel level. When correct amount is put, the user is not obliged to calibrate fuel level. The controller process this data if calibration process of fuel level was not done. After successful calibration of fuel level the controller does not process this value.
Extending time of feeder 2 work	Extension of the burner feeder operation time for the time of the feeder of the fuel hopper.
<b>Burning off</b>	
Maximum time of burning off	After this time the controller goes to PAUSE mode, in spite of the fact that the controller detects flame.
Minimum time of burning off	Burning off will last at least this time in spite of the fact that flame sensor indicated lack of flame.
Air flush intensity	Fan power during blowing while burning off in %.
Blowing time	Duration of blowing when burning off fuel and burning off.
Blowing pause	Break between airflows while burning off the fuel in burning off process.
Blowing start	Flame brightness with which airflow starts while burning off the fuel.

Blowing stop	Flame brightness with which airflow starts when burning off the fuel in burning off process
<b>Cleaning</b>	
Cleaning time Firing-up	Fan operation time during cleaning the furnace while firing up.
Cleaning time burning off	Fan operation time during furnace burning off.
Cleaning blowing	Fan power in % during furnace cleaning in burning off and firing up.
Rotary cleaning cycle	Rotary cleaning cycle period / time (basic)
<b>Supervision</b>	
Supervision time	After this time, when the controller is in SUPERVISION mode, the controller automatically starts burner burning off. By settings = 0, SUPERVISION mode is deactivated.
Feeding time	Fuel feeding in SUPERVISION mode. It has influence on burner power by operating in SUPERVISION mode. Attention: the value should be as small as possible, just to keep the flame burning. Too big value may cause to boiler overheating.
Cycle time	Feeder operation time in SUPERVISION mode. <i>Supervision cycle time = Supervision feeding time + feeder pause time in Supervision..</i>
Fan output	Fan power in % during operation in Supervision mode. Adjust value in such a way to burn feeding fuel in Supervision mode with low fumes emission.
<b>Grate</b>	
Blowing power - supervision	The duration of the fan blow in the supervision in grate mode.
Blowing pause - supervision	Interval between blows in the supervision in grate mode.
<b>Min. airflow output</b>	Minimum fan power in % which can be chosen by the user. It is only used to limit the accessible scope of fan power. It is not used in algorithm of controlling the fan. It should be possibly small to allow the fan to rotate slowly, without buzzing.
<b>Fuel shortage detection time</b>	Time is measured after decrease in brightness of flame below value <i>flame detection %</i> . After deducting this time the controller switches into firing up attempt. After 3 failed attempts, it reports alarm: "failed firing up attempt"
<b>Max. feeder temp.</b>	Max temperature of the feeder by which the alarm of exceeding the max. Temp of feeder will be switched on.
<b>Operation time of additional feeder</b>	Determines additional feeder operation time. Feeder is attached to additional module B. After this time additional feeder operation is stopped despite disconnecting joints of fuel level sensor. Joints of fuel level sensor are located in additional module B.

## 14.2 BOILER

<b>Boiler settings</b>	
<b>Thermostat select.:</b>	Options to choose from: <ul style="list-style-type: none"> <li>• Deactivated (deactivates room thermostat influence on boiler operation)</li> <li>• Universal (activates room thermostat for boiler)</li> <li>• ecoSTER200 T1 (option available after connecting room panel ecoSTER200, boiler operation is dependant on room thermostat No1 in ecoSTER200)</li> <li>• ecoSTER200 T2 (option available after connecting room panel ecoSTER200, boiler operation is dependant on room thermostat No 2 in ecoSTER200 – on sensor CT7)</li> <li>• ecoSTER200 T3 (option available after connecting room panel ecoSTER200, boiler operation is dependant on room thermostat No3 in ecoSTER200 – on sensor CT7)</li> </ul>
<b>Return protection *</b>	Group of parameters available after connecting return sensor, responsible for protection of boiler return in hydraulic installation with 4 way valve equipped in mixer servomotor. It is not advised to activate functions of return protection because it may cause frequent stops in power of mixer cycle. Instead this it is recommended to use bigger preset temperatures of boiler (70-75%) what in combination with installation with 4 way valve (with servomotor) it will cause automatic increase return temperature.
<b>Minimum boiler temperature</b>	Minimum preset boiler temperature which can be set in user menu and minimum temp. which can be set automatically by controller, i.e. from night reductions etc.
<b>Maximum boiler temperature</b>	Maximum preset boiler temperature which can be set in user menu and minimum temp. which can be set automatically by controller, i.e. from night reductions etc.
<b>Reserve boiler</b>	Description in point 12.13
<b>Alarms</b>	Description in point 12.14
<b>Boiler cooling temperature</b>	Temperature of boiler cooling off. Above this temperature the controller activates HW pump and opens mixer cycles to allow boiler cooling off. The controller activates HW pump if this temperature exceeds maximum value. The controller will not open mixer cycle when <i>mixer setting = floor on</i>
<b>Off by thermostat</b>	Options available <ul style="list-style-type: none"> <li>• NO (CH boiler pump is not activated when room thermostat starts operation),</li> <li>• YES (CH boiler pump is deactivated when room thermostat starts operating)</li> </ul>

### 14.3 CH and HW

<b>CH and HUW settings</b>	
CH activation temperature	Parameters determines the temperature at which CH boiler pump is activated. It protects the boiler against watering due to cooling off with cold water returning from installation. Attention: Deactivating boiler pump only does not guarantee boiler protection against watering and consequently corrosion. Additional automatics should be used, i.e. 4 way valve or 3 way thermostatic valve.
CH stand loading pause when HW *	Available after connecting HW sensor. Prolonged feeding of HW silo during priority HW deactivated may cause to overcooling of the CH installation, because CH pump is deactivated. Parameter CH pump pause during feeding HW prevents against periodical activating CH pump during feeding HW silo. CH pump after this time will activate on constant, programmed time of 30s.
Min. HUW temp. *	Available after CH sensor connecting. It is a parameter by which it can be reduced setting too low preset HW temperature.
Max .HUW. temp. *	Available after connecting HW sensor. Parameter determines to what maximum temperature HW silo will be heated during cooling the boiler in alarm situations. It is a very important parameter, because setting too high value of it may cause risk of scalding with HW. Too low value of parameter will cause that during boiler overheating it will not be possible to cool off the boiler to the HW silo. During design of HW installation, it is necessary to take into account risk of damaging the controller. Due to breakdown of the controller water in the silo can heat up to dangerous temperature. It is necessary to use additional protection in the form of thermostatic valves.
Boiler inc. by HUW, Mixer	Parameter determines how high the boiler temperature will be increased to load HW silo, buffer and mixer cycle. Temperature increase is only realizing when it is necessary. When preset boiler temperature is at sufficient level then controller will not change it due to the fact of feeding the HW silo, buffer or mixer cycle. Increasing preset boiler temperature during feeding HW silo is signaled with letter "C" in main window of displayer.
Extending HUW pump operation time *	Available after connecting HW sensor. After feeding HW silo and deactivating HW pump may be a risk of boiler overheating. It happens in case when preset HW temperature was higher than boiler preset temperature. This issue is exceptionally important in HW pump operation in SUMMER mode, when pump is deactivated. To cool off the boiler HW pump operation can be prolonged by <i>HW operation time prolongation</i> .
Circulating pump standstill time *	Parameters available after connecting additional module MX.03. Pausing time between periods of circulation pump operation is defined with value of parameter <i>Circulation standstill time</i> (recommended setting 15-40 min.) Circular pump operates constantly during <i>circulation operation time</i> . (recommended setting 60-120s)
Circulating pump operation time *	
Exchanger *	Parameter available after activating option Show advanced setup = YES. It only refers to hydraulic installation with heat exchanger between open and closed circuit, point 12.13. Available options:



	<ul style="list-style-type: none"> <li>• YES (boiler pump operates constantly in short circuit boiler – exchanger, it is not excluded i.e. from SUMMER function or HW priority)</li> <li>• NO (pump operates normally)</li> </ul>
--	---

#### 14.4 BUFFER

<b>Buffer settings</b>	
Activate operation	Parameter serves to activating buffer operating mode. Available after connecting additional module B and buffer temperature sensors.
Loading start temperature	Parameter buffer loading start temperature defines high temperature below which buffer feeding starts. Buffer feeding proces is finished when low temperature reaches value defined in parameter buffer feeding end temperature.
Loading end temperature	

#### 14.5 MIXER

<b>Mixer settings 1,2,3,4,5</b>	
<b>Mixer support</b>	
<ul style="list-style-type: none"> <li>• Off</li> </ul>	Mixer serwomotor and pump are not active
<ul style="list-style-type: none"> <li>• CH on</li> </ul>	Applicable when mixer cycle powers heating installation of CH. Maximum temperature of mixer cycle is not limited, mixer is fully opened during alarms i.e. boiler overheating. Attention: do not activate this option when installation is made of pipes sensitive to high temperature. In such situations it is recommended to set mixer service on FLOOR
<ul style="list-style-type: none"> <li>• Floor on</li> </ul>	Is used when mixer cycle powers floor installation. Maximum power of mixer cycle is limited to value of parameter max preset mixer temperature. Attention: After choosing option FLOOR, it is necessary to set parameter max mixer preset temperature on such a value to not damage the floor and avoid scalding risk.
<ul style="list-style-type: none"> <li>• Pump only</li> </ul>	When mixer cycle temperature exceeds value set in parameter mixer preset temperature, feeding of mixer pump is stopped. After decreasing temperature of circuit by 2 degrees C – pump is reactivated. This option is normally used to control floor heating pump in situation when it cooperates with thermostatic valve without servomotor. By such action is not recommended. It is recommended to use standard heating cycle in floor heating, which consists of valve, servomotor and mixer pump.
Thermostat select. *	Parameter available only after connecting to room panel ecoSTER200. This option allows change of room thermostat for mixer cycle. Options available: <ul style="list-style-type: none"> <li>• Universal – standard thermostat connected to terminals 28-30 for mixer 1, for mixers 2,3,4,5 use proper terminals in additional modules.</li> <li>• ecoSTERT1 – thermostat 1 in ecoSTER200/TOUCH,</li> <li>• ecoSTERT2 – thermostat 1 in ecoSTER200/TOUCH,</li> <li>• ecoSTERT3 – thermostat 1 in ecoSTER200/TOUCH,</li> </ul> If ecoSTER200/TOUCH is not connected then the controller cooperates with standard room thermostat.

Min. mixer temperature	Using this parameter it is possible to restrict Chance of setting to low preset mixer circuit temperature. Automatic control (i.e. periodical temperature reduction) also will not cause reduction in preset temperature below value set in this parameter.
Max. mixer temperature	Parameter serves two functions: - allows restricting setting too high mixer preset temperature. Automatic control also will not cause exceeding preset temperature above value set in this parameter. - with parameter mixer setting = activated FLOOR is also limit temperature of mixer sensor when mixer pump is deactivated. For floor heating set the value below 45 degrees C – 50 degrees C or other if producer of materials used for floor or CH installation designer state differently.
Valve full opening time	Set full valve opening time given at the plate of valve servomotor, i.e. 140s.
Off by thermostat	Setting the parameter on YES value causes closing of mixer servomotor and deactivating mixer pump after disconnecting joints of room thermostat. This is not recommended because the heated room can be too cool.
Mixer input dead zone *	Setting parameter determining value of temperature dead zone for mixer controlling circuit. The controller regulates mixer in such a way to keep the temperature of mixer cycle equal to preset value. However, avoid too frequent movements of servomotor, which can shorten its long-life usage. Regulation is undertaken only when measured temperature of mixer cycle will be higher or lower than preset value by the value bigger than mixer dead zone.

#### 14.6 ADVANCED PARAMETERS

<b>Show advanced setup</b>	Options available: <ul style="list-style-type: none"> <li>• YES (displays hidden parameters which edition is not recommended)</li> <li>• NO (hides hidden parameters)</li> </ul>
----------------------------	--

#### 15 DEFAULT SETTINGS RESTORING

<b>Default settings restoring</b>	Restoring service settings settings from main menu are restored.
-----------------------------------	--

## 16 ALARMS DESCRIPTIONS

### 16.1 BOILER MAX. TEMP. EXCEEDING

Protection against boiler overheating is done in 2 steps. In the first step, after exceeding *Boiler cooling off temperature*, the controller tries to reduce boiler temperature by dropping excess of heat to the HW silo and by opening mixer servomotors (only when *mixer service = activated CH*). If temperature measured by HW sensor exceeds value *Max. temp. of HUW* then HW pump is deactivated, what is done to protect users against scalding. If boiler temperature decreases, then the controller returns to normal operation. If the temperature will still increase (reaches 95 degrees C) then constant alarm will be activated of boiler overheating joined with sound signal.

The alarm can be deleted by pressing „TOUCH and PLAY” button or activating and deactivating power to the controller.



Locating temperature sensor outside water coat of burner i.e. on exhaust pipe is not beneficial, because it may cause delay in detecting boiler overheating state!

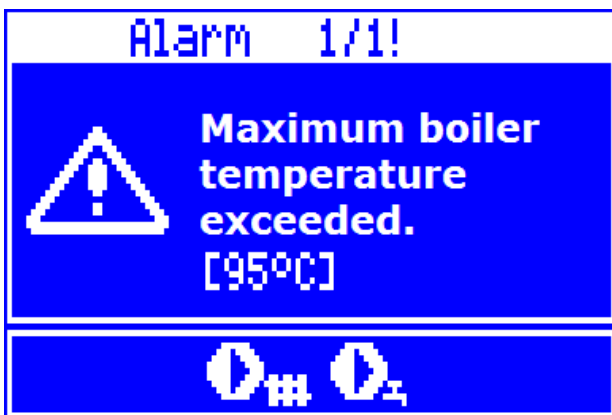

### 16.2 FEEDER MAX. TEMP. EXCEEDING

Alarm appears after exceeding feeder temperature above service parameter:

**MENU – Service settings – Burner settings – Max. burner temp.**

If the feeder temperature increases above this value the controller will begin burning off procedure.

Alarm is deleted automatically after feeder temperature decrease by 10°C.



Function which protects against back fire does not work when feeder sensor is disconnected or damaged.



Function which protects against back fire does not work when The controller has no electrical power.



The controller can not be used as sole protection of boiler against back fire. Additional protecting automatics is to be used.

### 16.3 BOILER TEMP. SENSOR DAMAGE

Alarm appears by boiler sensor damage and by exceeding measuring scope of this sensor. When alarm appears the boiler is activated. Deleting is done by pressing TOUCH and PLAY button or by deactivating and activating the controller. The sensor is to be checked and replaced if necessary.



Checking the temperature sensor is described in point 12.9

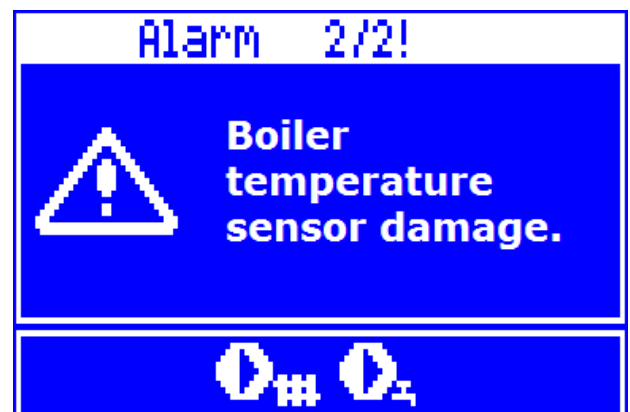

### 16.4 FEEDER TEMP. SENSOR DAMAGE

Alarm appears when feeder sensor is damaged or by exceeding measuring scope of this sensor. After alarm the boiler is burnt off.

Deleting is done by pressing TOUCH and PLAY button or by deactivating and activating electrical power to the controller.

It is necessary to check the sensor and replace it if necessary.

 Checking temperature sensor is described in point 12.9.

The controller can operate by disconnected feeder temperature sensor, after setting parameter *feeder max. temperature = 0*

 However it is not recommended, because it causes deactivation of boiler protection function against back-firing to fuel silo.

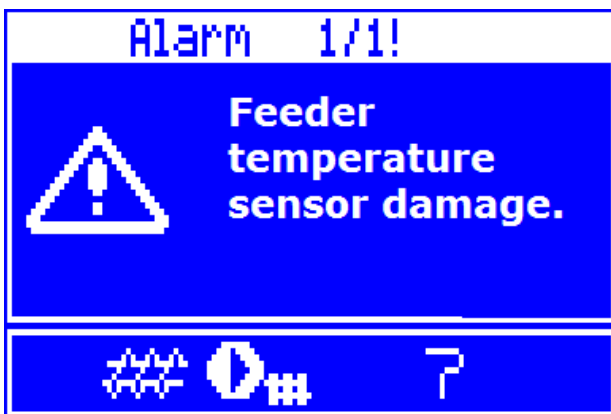

### 16.5 COMMUNICATION LOST

Controlling panel is connected to remaining electronics by digital communication joint RS485. In case of damage of this wire on the screen following information will be displayed: Attention! Lack of communication. The controller does not deactivate regulation and operates normally with previously programmed parameters. In case of alarm situation it will undertake action accordingly to given alarm.

It is necessary to check the wire connecting controlling panel with given alarm, then mend it or replace it if necessary.

### 16.6 FIRING UP FAILED ATTEMPT

Alarm will appear after third failed attempt of automatic furnace firing up. In case of alarm all pumps are deactivated in order to not cause excessive cooling of the boiler. Deleting is done by pressing TOUCH and PLAY button or by activating or deactivating

the controller. The cause of these alarms can be broken igniter or lack of fuel in the silo.

### 16.7 UNSUCCESSFUL ATTEMPT TO LOAD THE TANK

This is so called silent alarm reminder. It will take place by failed attempt of feeding fuel from additional silo. In case when through configured time of feeding the silo, installed sensor not detects increase of fuel the reminder is displayed. This signalization does not cause activating automatic boiler operation, there is only a warning displayed. Deleting is done by pressing TOUCH and PLAY button or by activating or deactivating power to the controller.

## 17 OTHER

### 17.1 POWER STOPPAGE

In case of power stoppage the controller returns to operation mode in which it was before stoppage.

### 17.2 ANTIFREEZING PROTECTION

When temperature of the boiler decreases below 5 degrees C CH pump will be activated enforcing circulation of boiler water. It will delay the process of freezing water, however in case of very low temperatures or by lack of electrical power it may not protect the installation against freezing.

### 17.3 PUMP ANTI STANDSTILL FUNCTION

The controller does the function of CH, HW and Mixer pumps protection against getting stale. It consists of a periodic switching on (each 167 h for several seconds). This protects the pump against immobilization due to scaling. Therefore, during a break in the use of the boiler, the regulator power supply should be connected. This is accomplished even when turned off using the keyboard controller (controller in the OFF state).

### 17.4 NETWORK FUSE REPLACEMENT

Circuit fuse is positioned inside the controller's cover. The fuse can only be replaced by a person holding proper qualifications and after disconnecting

electrical power. Porcelain fuses 5x20mm and time-lag fuses with nominal current 6,3A should be used. In order to take out the fuse unscrew the fuse cover and remove the fuse.

### **17.5 CONTROL PANEL REPLACEMENT**

It is not recommended to replace the panel itself as the program in panel must be compatible with program in other part of the controller.

### **18 LAMBDA SENSOR A**

Burner efficiency can be increased by connecting additional lambda sond module. Connect the module according to point 12.6. Lambda sond is to be activated in:

**Menu – Service settings – Burner settings – Lambda sond**

If parameter *Operation with Lambda sond* is set on "ON" then the controller will operate using lambda sond readings. The amount of air provided to the furnace will be automatically set in such a way to obtain preset amount of air in fumes. If this parameter is set on "OFF" then Lambda Sond readings will not have influence on controller's operation. Amounts of air for given burner power are set in:

**MENU –Boiler settings – Output modulation**

Description of remaining parameters related to Lambda sond: Parameter *Blow-in output scope* sets permissible scope of variability of airflow power by work using lambda sond. Parameters *Dynamics* and *Reaction time* have influence on regulation time of air amount in fumes to preset amount and on stability of air in fumes. It is not recommended to change these parameters if regulation time and stability of keeping preset amount of air on required level.

Periodical calibration of Lambda sond readings can be necessary. To conduct Lambda sond calibration it is necessary to extinguish the boiler. To make a successful calibration the furnace in boiler must be

completely extinguished. To start up the calibration use the parameter:

**Menu – Boiler settings – Lambda calibration**

Calibration process lasts approximately 8 minutes.

## 19 POSSIBLE FAULTS DESCRIPTION

Symptoms	Tips
1. There are no signs of operation of device despite connection to the network.	<p>Check:</p> <ul style="list-style-type: none"> <li>▪ If line fuses are not blown, replace if necessary</li> <li>▪ If the wire connecting panel with the executive module is plugged correctly and if module is not damaged.</li> </ul>
2. Preset boiler temperature on the display is different from the required one.	<p>Check:</p> <ul style="list-style-type: none"> <li>▪ If in this time the HW silo is not loaded and if preset temperature is set above the preset boiler temperature. If so then the difference in readings will disappear after heating the HW silo or reduce the preset HW temperature.</li> <li>▪ If time periods are activated – then deactivate time periods.</li> </ul>
3. CH pump is not working.	<p>Check:</p> <ul style="list-style-type: none"> <li>▪ If boiler exceeded temperature above parameter <i>temperature of activating CH pump</i> – wait or reduce value of this parameter.</li> <li>▪ If <i>HUW priority</i> is activated which blocks CH pump – deactivate priority by setting <i>HUW pump operation mode</i> on <i>No priority</i>,</li> <li>▪ If CH pump is damaged or blocked.</li> </ul>
4. Fan does is not working.	<ul style="list-style-type: none"> <li>▪ Check if plug jumper is installed for the limiter of safety temperature STB on terminals 1-2, (the jumper should only be installed only in case when temperature limiter is not connected).</li> <li>▪ If producer of the boiler has equipped it with temperature limiter STB with manual return to original position, it should be unlocked by untwisting the cover and twisting the button according to documentation of boiler producer,</li> <li>▪ Check the fan and replace it if necessary.</li> </ul>
5. Additional feeder is not working (module B).	<ul style="list-style-type: none"> <li>▪ Check if feeder wires are correctly connected to terminals,</li> <li>▪ Check if there is a jumper on terminals 1-2 of module B,</li> <li>▪ Check if feeder engine is not damaged,</li> <li>▪ In case when engine work can be heard and fuel is not provided check the feeder with its user manual.</li> </ul>
6. Fuel feeder is not working / does not provide fuel	<ul style="list-style-type: none"> <li>▪ Check if feeder wires are correctly connected to terminals,</li> <li>▪ If temperature limiter STB is connected to terminals 1-2, then check if the circuit is not cut off due to boiler overheating,</li> <li>▪ Check if feeder engine is not broken or damaged,</li> <li>▪ In case when engine work can be heard and fuel is not provided check the feeder with its user manual.</li> </ul>
7. Fuel is not burnt off completely, there are not burnt remnants in ashes. Fuel burns with big amount of smoke, burner fades	<ul style="list-style-type: none"> <li>▪ Check settings <i>power modulations</i> in: menu → boiler settings → power modulation.</li> </ul>
8. Temperature is not measured correctly.	<ul style="list-style-type: none"> <li>▪ Check if there is a good thermo contact between the temperature sensor and measured surface,</li> <li>▪ Check if sensor wire not goes too closely to network wire,</li> <li>▪ Check if sensor is connected to terminal,</li> <li>▪ Check if sensor is not broken – check with point 12.9.</li> </ul>
9. In HW pumps mode = SUMMER heaters are hot, boiler is overheated.	<ul style="list-style-type: none"> <li>▪ Increase value of parameter <i>HUW pump operation time extension</i> to cool off the boiler.</li> </ul>
10. HW pump is not working, even if HW silo is loaded	<ul style="list-style-type: none"> <li>▪ Set the parameter <i>HUW pump operation time extension</i> = 0</li> </ul>

<p>11. In hydraulic installation with mixing valve and serwomotor – mixer is not opening.</p>	<ul style="list-style-type: none"> <li>▪ The cause may be HW silo loading when HW priority is activated. Wait until HW is loaded or activate the HUW priority.</li> <li>▪ The cause may be active function SUMMER.</li> <li>▪ The cause may be activation of function return protection (menu – service settings – boiler settings – return protection). If function return protection is activated – check if return sensor of water return to silo is isolated thermically from surroundings. By usage thermoleading paste improve thermal contact of the sensor with pipe. Improve preset temperature of the boiler to ensure power for heating returning water. Check if hydraulic installation is correctly made, after closing the valve, return temperature must increase above value of parameter <i>Minimum return temperature</i>.</li> <li>▪ The cause may be calibration of mixer valve, wait until calibration is finished. Active calibration is marked "CAL" in menu INFORMATION.</li> </ul>
---	---

## 20 COTROLLER CONFIGURATION BY BOILER PRODUCER

The producer of boiler / burner should adjust program parameters in controller to given type and power of the burner. The most important parameters are those related to Firing up, Operation and Burning off. The controller is able to change the default settings depending on power and type of the burner. Default settings for given boilers / burners should be consultet with Company Plum Sp. z o.o.. In order to load new parameters go to **Menu – service settings – special password** and choose proper boiler/burner. Default settings can also be loaded by special software provided by Company Plum Sp. z o.o..

## 21 CHANGES REGISTER







**ul. Wspólna 19, Ignatki  
16-001 Kleosin  
Poland**

**tel. +48 85 749-70-00**

**fax +48 85 749-70-14**

**plum@plum.pl**

**www.pum.pl**

**www.plumelectronics.eu**